

MTS

We're with you.

MTS *Ultimate TV* User Guide



Table of Contents

Welcome to MTS <i>Ultimate TV</i>	1
MTS <i>Ultimate TV</i> set-top box equipment care and maintenance	2
Getting to know the buttons on your MTS <i>Ultimate TV</i> remote:	3
The TV Basics	4
Navigating the on-screen menus	4
Hide or remove channels from your guide	5
Setup Favourite channels	6
View Favourites	7
Search	8
Call Display on TV	9
MyRemote	10
How to use Descriptive Video and Closed Captioning	11
MTS Weather Channel	11
Lobby Camera	11
Whole Home PVR service	13
How many TVs can I watch at once?	13
Control Live TV	13
Set recordings	13
View upcoming/scheduled recordings	16
Play back recorded programs	16
Cancel, stop, erase recordings	18
Conflicts	18
Resolving recording conflicts	19
MyPVR	20
MTS Video on Demand	20
Accessing MTS Video on Demand	20
Play Video on Demand programs	20
Controlling Video on Demand programs	21
You are unsure of the expiration date for a video	21
The video expires while playing	21
A rented Video On Demand program is not in the Current Rentals list.	21
MTS Pay-Per-View events	21
Parental & rental locking – VOD and live TV	22
Default settings for Parental Locking	22
Movie and TV rating systems	22
Getting ready to use Parental Locking	23
Rental Locking	24
Watching a locked program	24
Changing the PIN	25
Forgot your Parental Control PINs?	25
Parental Control tips	25

Apps on TV	26
MyPicks	26
Ultimate Picks	27
On-TV messaging	28
How do I access messages in the Service and News log	28
How do I disable entertainment news pop-up notifications	28
How do I delete messages in the Service and News log	29
How do I know which messages in the log have been viewed	29
Purchasing Add-ons	29
The remotes	30
Remote control programming	31
Getting started	31
Program your MTS <i>Ultimate TV</i> remote to control your TV, DVD, home theatre receiver, or other devices	31
Power control for multiple devices	34
Learning	34
Set volume options for multiple devices	35
Reset the remote	37
Connections and devices	38
Connecting the MTS <i>Ultimate TV</i> set-top box	38
Troubleshooting	48
General troubleshooting:	48
Audio and picture troubleshooting	49
Guide troubleshooting	54
PVR troubleshooting	55
Remote troubleshooting	56
Quick TV fixes	56

Welcome to MTS *Ultimate TV*

Here are a few tips to help you get started:

- Keep your remote in “STB” or “MTS” mode to control your *Ultimate TV* service
 - If you’re pressing buttons on your remote and they don’t work, try pressing the [STB/MTS](#) button. (STB stands for “set-top box” – that’s the name of the *Ultimate TV* box under your TV!)
- You can instantly update your *Ultimate TV* channel package online 24/7
 - Customize your TV channel package with HD channels, premium movie networks, and more! Changes take effect in minutes. Visit mts.ca/myaccount
- MyPVR service
 - Set your PVR to record using a computer or mobile device! You can also browse the program guide and even delete recordings to free up space. All you need is to set up your MTS MyAccount
- MyPicks & Ultimate Picks
 - Did you know you can keep track of up to 6 channels at once on your *Ultimate TV*? Go to channels 92 & 93 to set them up.
- Check and pay your MTS bills online
 - Sign up for online bill, preauthorized payment, or make a one-time payment on your account. Just go to mts.ca/myaccount to get started

Equipment care and maintenance

- TO REDUCE RISK OF ELECTRIC SHOCK, DO NOT REMOVE COVER (OR BACK).
- PVR Set-top boxes (VIP 1216/2262) contain a hard drive, which means they require careful handling to avoid damaging the drive.
- To allow the hard drive to spin down properly, wait at least 10 seconds after disconnecting power before moving the Set-top box.
- Must be positioned horizontally and rest on their rubber feet. Do not attempt to mount or position it in a vertical position.
- Do not position the Set-top box near any external heat source such as a heater or radiator.
- Do not place the Set-top box on a rug or bed as it may overheat.
- Do not stack other electronic equipment on top of it.
- Allow for at least two inches of free space above the Set-top box and ensure the vents on the Set-top box are not blocked.
- Protect the power cord from being walked on or pinched, particularly at plugs, convenience receptacles, and the point where they exit from the apparatus.
- Contact MTS if the Set-top box gets damaged in any way, such as if the box is dropped, the power supply cord or plug is damaged, liquid is spilled on it, objects have fallen into it, or it has been exposed to rain or moisture.

VIP 1216 PVR



VIP 2262 PVR



Note: set top box models may vary

Getting to know your remote control

Set your TV to STB mode or your MTS service will not work. On some remotes this button is labelled **MTS**.

Record TV* with just one click

Skip back in 7-second increments

Go to Video On Demand library (Note: **On DEMAND** button may be called **VIDEO ON DEMAND** on some remotes)

Go to Main Menu

Program MTS remote control to TVs/DVDs or auxilliary devices. (Note: **LEARN** button may be called **SETUP** button on some remotes)

When in Guide, return to last screen or Main Menu

Exit from **MENU** screen to TV

Search

Go to Interactive Program Guide

Edit letters or numbers on the **SEARCH** screen



Change video input (Must be in TV mode for TV service to work)

Pause Live TV*

Skip forward in 30-second increments. (Note: **FWD** button may be called **SKIP FORWARD** on some remotes).

Go to list of recorded TV programs*

Launch MyMenu, your customizable menu app

Navigate channels, menus and screens using arrows

Go to **PROGRAM INFO** screen

Customize using MyRemote

Return to the previously viewed TV channel or a list of previously viewed channels

While watching TV, change screen dimentions to fit wide-screen TV

While in Guide, jump channel listings by tonight, tomorrow or the next 14 days

While in Guide, easily add a channel to your Favourites list (Note: **ENTER/ASPECT** button may be called **OPTIONS** on some remotes)

TV Basics

Navigating the on-screen menus

Menus and screens

When in the MENU, GUIDE, MTS Video on Demand, or Recorded TV screens:

- Use the **ARROW** buttons and/or the **CH | PG** button to highlight items in the screen. The highlighted item shows the selection
- Press **OK** to activate the selection
- Press **BACK** to return to the previous screen
- Press **EXIT** to return to TV viewing

The Menu

The Menu screen provides access to the features:

- Press **MENU**, the Menu screen appears
- Press the **UP/DOWN ARROWS** to highlight a heading, such as Live TV, on the vertical menu bar
- Press the **UP/DOWN ARROWS** to highlight a submenu, such as Guide, press **OK**
- Press the **LEF/RIGHT ARROWS** to highlight an item and press **OK** to select the item
- Press **EXIT** to return to TV viewing



The Program Guide

- Press **GUIDE**
- Press the **UP/DOWN ARROWS** or the **CH | PG** to scroll vertically through the Guide. Press and hold the **CH | PG** button to go through a whole page of the Guide at a time
- Press the **RIGHT/LEFT ARROWS** to scroll horizontally through the Guide to see what is playing at a later time
- The **REW** or **FF** buttons will go ahead a day or back a day in the Guide
- Highlight the program and press **OK**. If the program is currently available, it will begin playing
 - If the program is on at a later time, the Program Info screen appears with options to choose from
- Press **ENTER/OPTIONS** button to jump ahead up to 14 days in the Guide
- Press **EXIT** to return to TV viewing

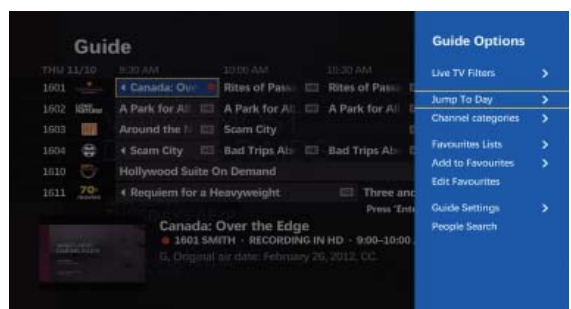
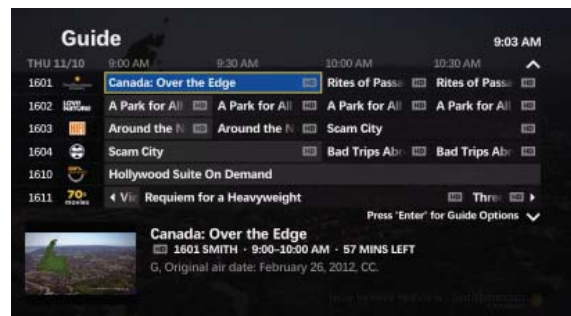

The Program Info screen

The Program Info screen displays information about all programs in the Guide, and provides access to a variety of options related to the program.

- Press **GUIDE**
- Press the **UP/DOWN ARROWS** or **CH | PG** to highlight the program
- Press **INFO** and the Program Info screen appears
- Under the **SUMMARY** heading, highlight one of the following options and press **OK**
 - **WATCH** – To tune to the program if it is currently on
 - **RECORD EPISODE** – To record the program
 - **RECORD SERIES** – To record the series for this program

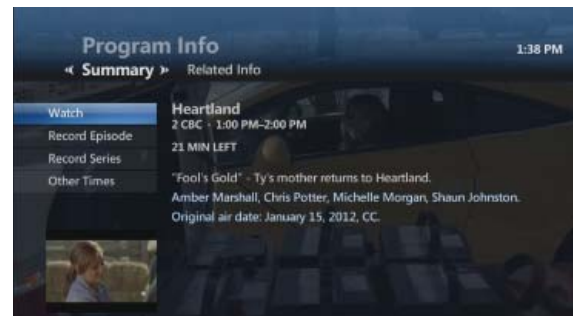

User Tip: Record Episode and Record Series options requires a subscription to PVR service

- **RENT** – To rent the program. This option only appears in the Program Info screen for a Video on Demand movie
- Press the **RIGHT ARROW** button to highlight **RELATED INFO** on the horizontal menu bar to find out additional details of the program.

Hide or remove channels from your guide

Only want to see the channels you watch in your guide? You can customize which channels are shown in the Guide. Customized Guide only affects the TV it on which it was setup. Each TV can have its own customized Guide.

- Press **MENU**
- Press the **DOWN ARROW** to highlight **SETTINGS**
- Highlight **TELEVISION** and press **OK**
- Highlight **CUSTOMIZE CHANNEL GUIDE**, and press **OK**

Note: Channels currently displayed in the Guide have a check mark in front of them. Channels that are not currently displayed in Guide do not have a check mark in front of them

- Use the **UP/DOWN ARROWS** or **CH | PG** button to go through the list of channels. The following options are available:
 - To hide a channel currently in the Guide, highlight the channel, and press **OK**. The check mark disappears from the check box
 - To make a hidden channel reappear in the Guide, highlight the channel, and press **OK**. A check mark appears in front of the channel
 - To make all channels appear in the Guide, highlight **CHECK ALL**, and press **OK**. Check marks appear in all the check boxes
 - To display only the unchecked boxes (hidden channels), highlight **VIEW UNCHECKED**, and press **OK**. The **SHOW UNCHECKED** option becomes **SHOW ALL**
 - To restore the entire list, highlight **SHOW ALL**, and press **OK**
- To save the settings, highlight **SAVE**, and press **OK**. Select **DON'T SAVE** to exit from the screen without saving the settings

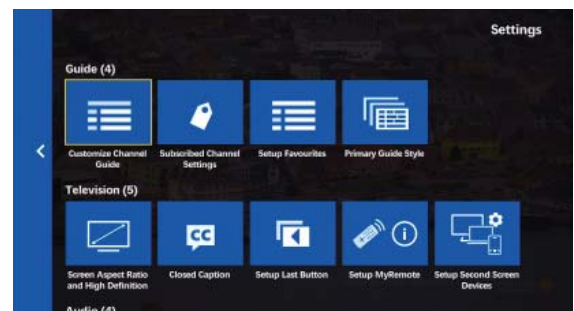

User Tip: Channel 51 DVR (Recorded TV) and 53 VIDEO (Video on Demand) cannot be deleted from the Guide

Subscribed channel filter

Enabling the filter only displays channels that are subscribed to

- Press **MENU**
- **DOWN ARROW** to **SETTINGS** then **DOWN ARROW** to highlight **GUIDE** and press **OK**
- Highlight **SUBSCRIBED CHANNEL SETTINGS** and press **OK**
 - To display only channels you subscribe to in the guide, select **VIEW SUBSCRIBED** and press **OK**
 - To display all channels including channels you are not subscribed to, select **VIEW ALL** and press **OK**
- Press the **LEFT ARROW** to highlight **SAVE** and press **OK**
- To cancel the changes, highlight **DON'T SAVE** and press **OK**

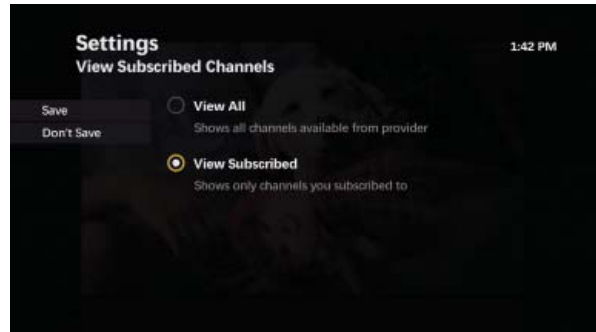
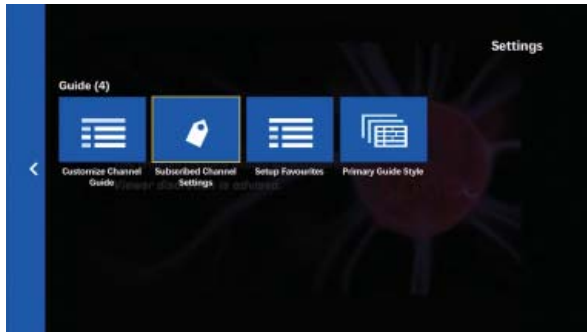

Setup Favourite lists

Group your most watched channels together in your own favourites list so they are easy to find.

- Press **MENU**
- **DOWN ARROW** to **SETTINGS**, then **DOWN ARROW** to highlight **GUIDE** and press **OK**
- Highlight **SETUP FAVOURITES**, and press **OK**, Highlight **SET UP...**, and press **OK**
- Use the **UP/DOWN ARROW** buttons or **CH | PG** button to scroll through the list of channels.
- Press **OK** to select or deselect the checkmark beside the channel
 - A checkmark includes the channel in the favourite list
 - An empty check box removes the channel from the favourite list

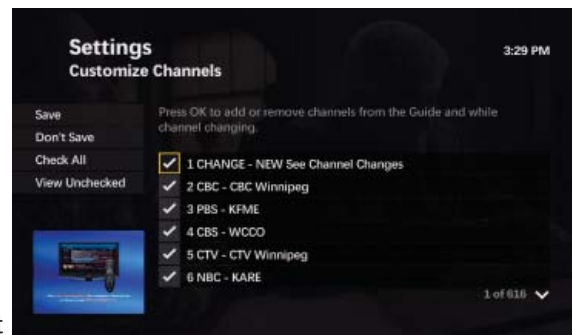

From the menu on the left the following options are available:

- To reset the favourite channels list, highlight **UNCHECK ALL**, and press **OK**. All the check boxes become unchecked
- To only show the channels in the favourite channels list, highlight **VIEW CHECKED**, and press **OK**. The **VIEW CHECKED** option becomes **VIEW ALL**
- To show the entire list of channels, highlight **VIEW CHECKED**, and press **OK**, then highlight **VIEW ALL**, and press **OK**
- To update the order in which channels display on the favourites guide, highlight **CHANGE ORDER**, and press **OK**
- Press the **LEFT ARROW** to move to the left side of the screen, highlight **SAVE** and press **OK**
- To cancel the changes highlight **DON'T SAVE** and press **OK**
- Repeat the steps to create up to 5 individual favourites lists

View Favourites

- Press **MENU**
- **DOWN ARROW** to **LIVE TV**, and **DOWN ARROW** again to **FAVOURITES**
- To select the favourite list you want to view, highlight the list and press **OK**, your Favourites Guide will be displayed
- To exit your Favourites List, select **VIEW ALL CHANNELS**
- To add channels to your Favourites List, select **EDIT FAVOURITES**, and press **OK**, and then highlight the Favourites list you want to update, and press **OK**
- Favourite channels are effective only on the TV on which they were setup

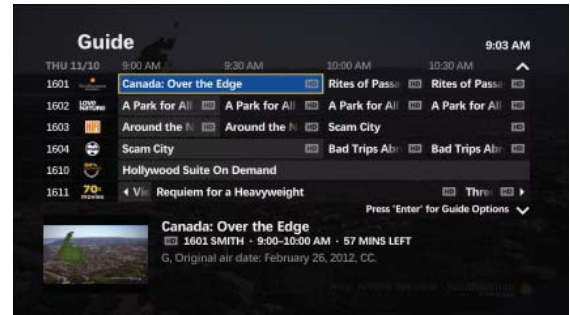

Rename Favourites list

- Press **MENU**
- **DOWN ARROW** to highlight **LIVE TV**
- **DOWN ARROW** to highlight **FAVOURITES** and press **OK**
- Highlight **SETUP FAVOURITES LISTS** and press **OK**
- Highlight the Favourite List you want to rename and press **OK**
- Press **ENTER / ASPECT**, button
- Highlight **RENAME THIS LIST** and press **OK**
- Use the **ARROW** buttons to select the letters on the **ALPHABETIC KEYPAD** and enter the List Name (use the <- button to delete a number/letter)
- Highlight **SAVE** and press **OK**
- Press **EXIT**

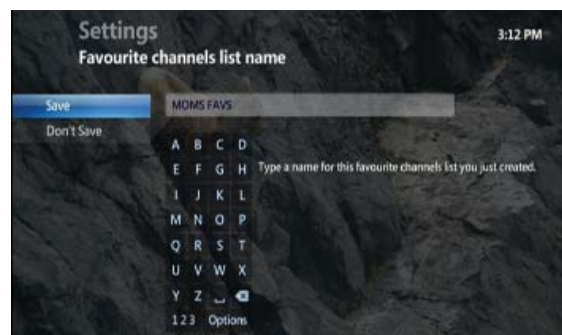

Delete Favourites list

- Press **MENU**
- **DOWN ARROW** to **LIVE TV**, and press **OK**
- **DOWN ARROW** to highlight **FAVOURITES**, and press **OK**
- Highlight the Favourite channels you want to delete and press **OK**
- Press **ENTER / ASPECT**, button
- Highlight **REMOVE FROM FAVOURITES**, and press **OK**
- Select **DON'T DELETE** to cancel
- Press **EXIT**



Search

You can search the guide and Video on Demand for your favourite programs from one place. You can also search by program name or actor.

- Press the **A** button (Yellow Triangle), or;
- Press **MENU**, then **UP ARROW** to **SEARCH** and press **OK**
- The Search screen appears with the following:
 - Use the **ARROW** buttons to select letters on the **ALPHABETIC KEYPAD** to search for the program or person, and press **OK**
 - Press **[]** to add a space between words
 - Press **→** to delete a letter/number
 - Press **123** to activate the numeric keypad
- On the right side of the screen, a list of programs or names that contain the letter or number entered appear
- To narrow the search, highlight **OPTIONS** and press **OK**. The following filters are available:
 - **ALL RESULTS** – Displays people, program titles, and Video on Demand programs
 - **TITLES** – Titles from Live TV and VOD display (“VIDEO” indicates VOD titles)
 - **VIDEO ON DEMAND** – Only VOD programs display
 - **CAST AND CREW** – Only programs with the person appear
 - **CHANNELS** – Only channel names appear
- The first 5 results will display along with posters on the right. If your result is not in the first 5 posters use the **ARROW** buttons to highlight the **VIEW ALL** icon on the far right and press **OK**.
- Use the **ARROW** buttons to highlight the title or name from the list on the right, then press **OK**.
 - If the filter is set to **TITLE**, times when the program is playing displays along with program details at the bottom of the screen. Programs are displayed in sub-categories such as ON DEMAND and LIVE.
 - If the filter is set to **PEOPLE**, programs featuring that person appear along with program details at the bottom of the screen
 - If the filter is set to **VIDEO ON DEMAND**, the Program Info Summary screen appears with program detail along with rental information

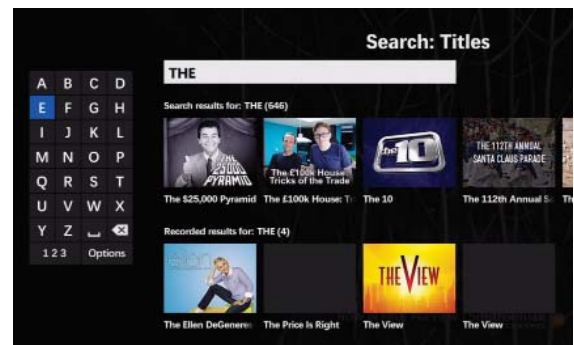

User Tip: A quick way to access search options is to press the **ENTER/ASPECT** button on your remote while the search menu is open.

- Press **EXIT** to return to Live TV

Call Display on TV

See who's calling right on your TV screen with MTS Ultimate TV® Message Centre. TV Call Display is free when you subscribe to MTS Call Display on your MTS home phone. This feature is not available in Steinbach.

Accessing the last call received

- Press the **MENU** button on your MTS TV remote control
- Press the **DOWN ARROW** button to navigate to **EXTRAS**, press **OK**
- Press the **RIGHT ARROW** button to navigate to **CALL DISPLAY LOG**, press **OK**
- Your call log will be displayed. The last call received will display first in the list
- Press **EXIT** until you return to TV viewing

How to personalize your Call Display settings

- Press the **MENU** button on your MTS TV remote control
- Press the **DOWN ARROW** button to navigate to **EXTRAS**, press **OK**
- Press the **RIGHT ARROW** button to navigate to the **CALL DISPLAY OPTIONS**, press **OK**

Once in Call Display Settings, you can:

A. Disable TV Call Display

- To turn TV Call Display off, use the **ARROW** button to navigate to enable **TV CALL DISPLAY OFF** and press **OK**. TV Call Display will continue to display on other TVs until disabled. Press **LEFT ARROW** to navigate to **SAVE**, press **OK**

B. Change How Long TV Call Display shows On Your TV Screen

- Use the **ARROW** button to access **DISPLAY ON TV FOR** option
- Using the number buttons on the remote, type in the number of seconds you'd like TV Call Display to appear on the screen (between 1 and 99).

C. Change TV Call Display Location on Your TV Screen

- Press the **DOWN ARROW** button and navigate to **DISPLAY LOCATION OPTIONS**
- Choose the location on your TV that you would like the TV Call Display indicator to appear
- To select this location, press **OK**

Once you are done with the settings you can press the **LEFT ARROW** button to navigate to **SAVE**, press **OK**

How to delete calls from your Call Display log

- Press the **MENU** button on your MTS TV remote control
- Press the **DOWN ARROW** button to navigate to **EXTRAS**, press **OK**
- Press the **RIGHT ARROW** button to get to **CALL DISPLAY LOG**, press **OK**. Your call log will be displayed
- Press the **DOWN ARROW** button to select the Call Log you wish to delete, press **OK**
You will default to **DELETE ITEM**, press **OK**. If at any time you do NOT wish to delete that item, you may select **BACK** from this window and press **OK**. You will be directed back to Call Log screen
- Press **EXIT** until you return to TV viewing



Name	Phone Number	Date / Time
Unknown Name	Unknown Number	Mar 23, 2:04 PM
Unknown Name	Unknown Number	Mar 23, 2:04 PM
Morty	+1222041234567	Mar 23, 2:04 PM
Morty	+322041234567	Mar 23, 2:04 PM
Morty	1 (204) 123-4567	Mar 23, 2:04 PM
Morty	1 (204) 123-4567	Mar 23, 2:03 PM
Morty	(204) 123-4567	Mar 23, 2:03 PM
Morty	(204) 123-4567	Mar 23, 2:03 PM
Unknown Name	Unknown Number	Mar 23, 2:03 PM
Private Name	Private Number	Mar 23, 2:01 PM

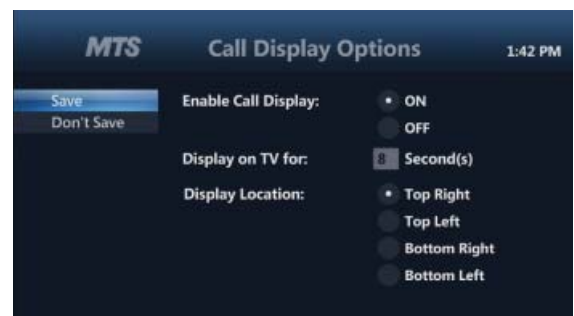

To delete all call logs

- Press the **MENU** button on your MTS TV remote control
- Press the **DOWN ARROW** to navigate to **EXTRAS**, press **OK**
- Press the **RIGHT ARROW** to get to **CALL DISPLAY LOG**, press **OK**. Your call log will be displayed
- Press **OK** from any Call Log
- You will default to **DELETE ITEM** on the next window, press the **DOWN ARROW** to navigate to **DELETE**, press **OK**
- You will default to **YES** on the next window, press **OK**. If at any time you do NOT wish to delete all items, the user may select **NO** from this window and press **OK**. User will be directed back to Call Log screen
- Press **EXIT** until you return to TV viewing

User Tip: When deleting a call from the call log, the call will be deleted from all TVs.

MyRemote

MyRemote lets you customize the A, B, and C buttons on your remote for one-touch access to your favourite MTS Ultimate TV channels, menu options, and applications.

How to set up or change the A, B, and C buttons

- Press **MENU** on your MTS TV Remote
- Use the **DOWN ARROW** to select **SETTINGS** and press **OK**
- Use the **DOWN ARROW** to select **TELEVISION** and press **OK**
- Use the **RIGHT ARROW** to select **SETUP MYREMOTE** and press **OK**
- Use the arrow buttons on your remote to select **CHANGE** next to the button that you want to customize (A, B, or C) and press **OK**
- Select the action to which you want to have one button access. You can choose from options in the following categories:
 - Menu Options (where you will find Closed Captioning and Descriptive Video)
 - Applications
 - TV Channels (simply enter the channel number of your favourite channel here)

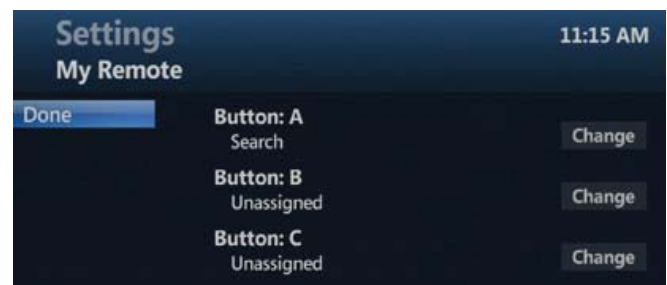
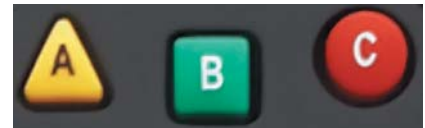

How to use Descriptive Video and Closed Captioning

Closed Captioning

Set up Closed Captioning using MyRemote

If you use closed captioning on a regular basis you should use MyRemote to set your **B** or **C** button on your remote to turn closed captioning on or off.

How to use Captioning

Once you have set up closed captioning on your remote you can turn it on or off by simply pressing the **B** or **C** button – whichever button you chose in the MyRemote steps above.

Note: You will also need to enable Closed Captioning on your television set, per the instructions provided by your TV manufacturer.

Descriptive Video

Descriptive Video lets visually impaired people access a second stream of audio, describing non-verbal actions in a program. The most up to date list of channels offering Descriptive Video is available at mts.ca/descriptivevideo

Set up Descriptive Video using MyRemote

If you use descriptive video on a regular basis you should use MyRemote to set your **B** or **C** button on your remote to turn descriptive video on or off.

How to use Descriptive Video

Once you have set up descriptive video on your remote you can turn it on or off by simply pressing the **B** or **C** button – whichever button you chose in the steps above.

Descriptive video will only have audio if the show has descriptive video.

MTS Weather Channel

The MTS Weather Channel is available on Channel 29 and features local weather 24/7.



Lobby Camera

MTS Lobby Camera lets tenants with *Ultimate TV* in select apartments and condos view their lobby directly on their TV screen.

- Tune to channel 1095



- Press **OK** to start the Lobby Camera access. You will be presented with a video stream of your building's lobby camera
- To tune away from the Lobby Camera access, change the channel

***User Tip:** The Lobby Camera doesn't need a television stream, so accessing the Lobby Camera will not cause a conflict with any programming that you may be watching or recording.*

Whole Home PVR Service

You must subscribe to PVR service to use this section. To subscribe to PVR service call MTS at 204-225-5687.

Whole Home PVR turns all your set-top boxes into HD PVRs.

With Whole Home PVR you can:

- Set and play back different recorded shows at the same time throughout the house via one PVR
- Start a recorded show in one room, and finish in another
- Pause, rewind, and replay live TV at all connected TVs

How many TVs can I watch at once?

With MTS *Ultimate TV* your house can watch up to 7 programs at the same time:

- **Watch or record Live TV:** Watch or record up to 3 HD or SD shows at the same time
- **Play back recorded TV:** Play back up to 4 previously recorded shows in HD or SD (one of the feeds needs to be at your PVR box)

If you try to watch or record more than the above, you will get a **CONFLICT MESSAGE**. Follow the on-screen instructions to resolve the conflict and continue watching TV.

User Tips:

If two TVs are tuned to the same live channel it counts as one live show.

Video on Demand counts as a live TV show, not a previously recorded show.

Control Live TV

Control live TV using the **PAUSE**, **FAST-FORWARD**, and **REWIND** buttons.

- **REPLAY** skips back 7 seconds and **FWD** skips forward 30 seconds
- Recording Live TV starts from the point at which **RECORD** is pressed, not from the beginning of the program
- A PIN is not required to schedule recordings for programs that are locked by the parental locking feature; however the PIN is required to view the recording
- Press **PAUSE** to pause the program for up to 90 minutes
- If paused longer than 90 minutes, the program automatically begins to play from the point at which it was paused

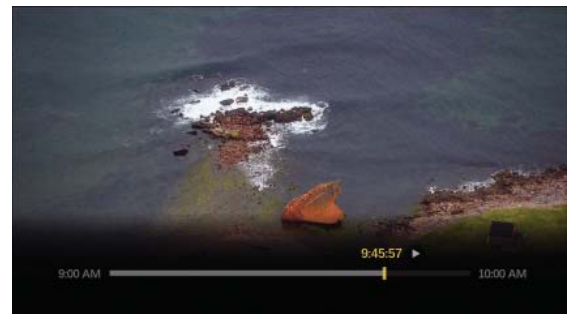

Set Recordings

How to record a single program/episode

While watching live TV you can record the current program until its scheduled end time, or add extra time at the end to ensure that the whole program records.

- While watching live TV, press **RECORD** to record the channel you are currently on
- You can also go into the **GUIDE**, highlight the name of the show you want to record, and press **RECORD**

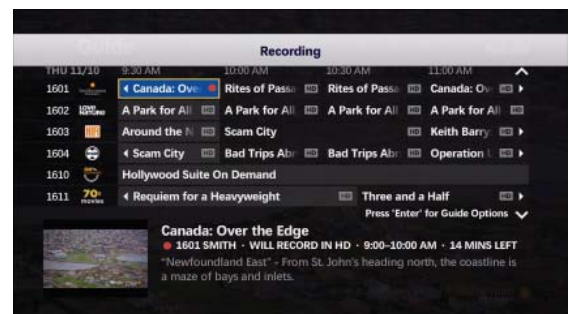

How to change single recording settings

- Press **RECORDED TV**
- Use the **ARROW** buttons to highlight the program recording (indicated by a red dot)
- Press **OK**. The recording info page appears
- Highlight **RECORD SETTINGS**, and press **OK**. The Record Settings screen appears
- Use the **ARROW** buttons to highlight the text under **STOP RECORDING**, and press **OK**
- Highlight one of the following options, and press **OK**
 - At Scheduled Time
 - 5 Minutes After
 - 15 Minutes After
 - 30 Minutes After
 - 1 Hour After
 - 2 Hours After
 - 3 Hours After

Or, highlight **DON'T CHANGE** and press **OK** to keep your current setting

- Highlight text under **KEEP UNTIL**, and press **OK**
- Highlight one of the following options, and press **OK**
 - **SPACE NEEDED** – Automatically erases the program when space is needed for a new recording. The oldest recording will be the first to be erased if space is needed
 - **I ERASE** – Stores the program until it is erased manually
- Or, highlight **DON'T CHANGE** and press **OK** to keep current setting
- Use the **ARROW** buttons to highlight **SAVE CHANGES**, and press **OK**
- **RECORDING UPDATED** message appears for a few seconds
- Highlight **WATCH** and press **OK**, to return to Live TV

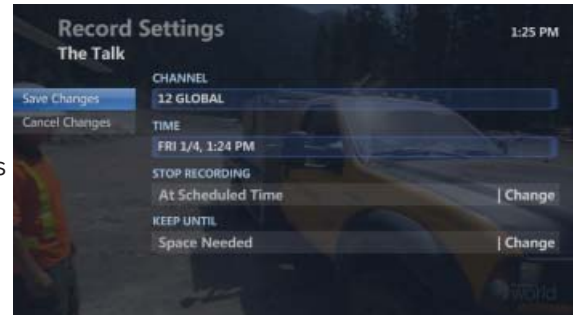

How to record a series

Record recurring programs, such as episodes in a series. Once scheduled, a series recording occurs until cancelled. Scheduled recordings continue even when the TV and receiver are off.

- While watching live TV, press **RECORD** twice to record the series you are currently watching
- You can also go into the **GUIDE**, highlight the name of the series you want to record, and press **RECORD** twice
- One-touch recording defaults to a weekly series recording

How to change series recording settings

- Press **RECORDED TV**
- Use the **RIGHT ARROW** to highlight **SERIES**
- Highlight the series name and press **OK**. The Series Info screen appears
- The following can be changed, **TIME**, **SHOW TYPE**, and **STOP RECORDING**
- Use the **ARROW** buttons to highlight selection and press **OK**
 - **TIME**
 - Any day, around HH:MM AM/PM
 - Any day, anytime
 - Any day, anytime, once per day
 - **SHOW TYPE**
 - First Run & Rerun
 - First Run Only



- **STOP RECORDING**
 - At Scheduled Time
 - 5 Minutes After
 - 15 Minutes After
 - 30 Minutes After
 - 1 Hour After
 - 2 Hours After
 - 3 Hours After
- Highlight your choice and press **OK**
- When choices have been selected, highlight **SAVE CHANGES** and press **OK**
- The Series info screen appears. Press **EXIT** to return to Live TV

How to record manually

Use this feature if you want to override the info in the Guide and record for a specific amount of time. Schedule a recording manually by specifying the channel, date, time, and duration. This feature can only be used for single programs (not series).

How to Create a Manual Recording:

- Press **RECORDED TV**
- **RIGHT ARROW** to highlight **ADD RECORDING**
- Highlight **CHANNEL AND TIME**, and press **OK**. The Manual Record screen appears
- Highlight the text entry box under **CHANNEL**. Use the **NUMERIC KEYPAD** to enter the channel to record
- Highlight the text entry box under **DATE**, and press **OK**. Highlight the date you want, press **OK**
- **DOWN ARROW** to highlight **MON/DATE | CHANGE** under **DATE** and press **OK** to change the recording date
- Highlight the text entry box under **START**. Use the **NUMERIC KEYPAD** to enter the time to start recording. **RIGHT ARROW** and press **OK** to change to AM or PM
- Highlight the text entry box under **STOP**. Use the **NUMERIC KEYPAD** to enter the time to stop recording. **RIGHT ARROW** and press **OK** to change to AM or PM
- To set how long the recording is to be stored, highlight the text under **KEEP UNTIL**, and press **OK**
Highlight one of the following options and press **OK**
 - **SPACE NEEDED** – Automatically erases the program when space is needed for a new recording. The oldest recording will be the first to be erased if space is needed
 - **I ERASE** – Stores the program until it is manually erased
- Highlight **RECORD** and press **OK**. Or, highlight **DON'T RECORD** and press **OK** to cancel the recording
- The message “Recording Scheduled” appears for a few seconds
- Press **EXIT** to return to Live TV

How to check the program is recording

- When a program is recording the red light under **RECORD** will be seen on the receiver
- In the Guide, individually scheduled recordings are marked by a red dot and series recordings are marked by three overlapping dots
- Scheduled recordings continue even when the TV and receiver are off
- Press **RECORDED TV**. This screen displays the title of a recorded program with a red dot as soon as it begins recording. Scroll to **SCHEDULED** to see programs that will be recorded



When do my programs get deleted

If the system has less than 25 MB of free disk space (which allows only a few minutes of playing time), the oldest program, based on the recording start date, is automatically deleted.

To ensure important programs are saved, monitor the disk usage and pre-emptively delete old or unwanted recordings.

How to check PVR capacity

Check the capacity of your PVR by:

- Pressing the **MENU** button
- Use the **DOWN ARROW** to highlight **RECORDED TV**
- Use the **RIGHT ARROW** to choose **PVR SPACE**
- Press **OK** on your remote

View upcoming/scheduled recordings

How to view scheduled recordings

- Press **RECORDED TV**. The Recorded TV screen appears
- Press the **RIGHT ARROW** button to highlight **SCHEDULED** on the horizontal menu bar. The Recorded TV screen now lists all upcoming recordings in the order in which they will be recorded
- Use the **ARROW** buttons or **CHIPG** to scroll through the list



How to view series recordings

- Press **RECORDED TV**. The Recorded TV screen appears
- Press the **RIGHT ARROW** button to highlight **SERIES** on the horizontal menu bar. The Recorded TV screen lists the series scheduled to record
- Use the **ARROW** buttons or **CHIPG** to scroll through the list

Playback recorded programs

- Press **RECORDED TV**. The Recorded TV screen lists available recordings by date, from the most recently recorded programs to the oldest
- Recordings that have not been viewed will be displayed in white, already viewed programs are displayed in grey
- Use the **ARROW** buttons or **CHIPG** to scroll through recorded programs
- Highlight a recorded show, and press **OK**
- The Program Info screen appears:
 - Highlight **PLAY**, and press **OK** to play the recording from the beginning
- **User Tip:** If the recorded program is locked by parental locking, refer to Parental Locks.
- If the recorded program is stopped, to continue watching, highlight **RESUME PLAY**, and press **OK**
- If the recorded program is stopped, to start watching the program from the beginning, highlight **START OVER** and press **OK**



- After the program finishes playing the Finished screen appears with the following menu options:
 - **START OVER** – Watch the program again
 - **ERASE** – Erase the program
 - **RECORDED TV** – Returns to recorded programs for another selection
 - **WATCH LIVE TV** – Returns to live programming

Watch next episode

You can view the next episode of a series that has been recorded.

- After recording has ended, or by pressing **STOP**
- Highlight **WATCH NEXT EPISODE** and press **OK**
 - Highlight **YES** and press **OK** to erase your currently viewed episode
 - Highlight **NO** and press **OK** to keep your currently viewed episode
- The next episode in the series will begin playback
- This option will not be displayed if the episode you are viewing is the only recording of the series or there are no future episodes recorded
- Already viewed episodes will display in grey and unwatched episodes will display in white



Viewing and playing recently recorded programs

You can view and playback the last 5 recorded programs.

- Press the **UP ARROW** on your remote control twice
 - The first time you press the **UP ARROW** you will see the last 5 channels you have viewed
 - The second time you press the **UP ARROW** you will see the last 5 programs recorded to you PVR
- Use the **RIGHT ARROW** to highlight one of the recent PVR recordings and press **OK** to watch that program

Cancel, stop, erase recordings

How to cancel recording from the Guide

The easiest way to cancel a single or series recording is by using the Guide. Individually scheduled recordings are marked by a red dot, and series recordings are marked by three overlapping dots.

- Press **GUIDE**
- Use the **ARROW** buttons or **CHIPG** to scroll through programming, highlight the program (red dot(s) indicate recording) to be cancelled
- Press **RECORD** twice for a single recording or once for a series recording
- A “Recording Cancelled” message appears on the screen

How to stop recording

- While watching a program being recorded, press **STOP**
- A message appears that lets you stop or continue recording
- Highlight **STOP RECORDING**, and press **OK**. The message “Recording Stopped” appears
Or, highlight **KEEP RECORDING**, and press **OK**
- If the program is stopped a message appears “Recording Stopped”

How to erase existing recordings

Recorded programs remain until they are erased, or until the receiver erases old recordings to make space for new recordings (this can be set under **CHANGING HOW LONG THE RECORDING WILL BE STORED**)

- Press **RECORDED TV**
- Use the **ARROW** buttons or **CHIPG** to scroll through recorded programs
- Highlight the recorded program to be erased, and press **OK**. The Program Info screen appears
- Highlight **ERASE**, and press **OK**. A confirmation message appears
- Highlight **ERASE** again, and press **OK**. The message “Recording Erased” appears and the program is permanently erased
- Select **DON'T ERASE** to keep the program
- The Recorded TV screen appears. Press **EXIT** to return to live TV



Conflicts

A “Conflict Resolution” message will appear on your screen when you exceed the number of simultaneous actions your TV service can perform.

- If more than four televisions are trying to access different channels, you will be given the following options. Highlight the option you want, and press **OK**
 - **STAY ON CHANNEL** – This option will keep the TV on the current channel
 - **INTERRUPT A TV** – This will turn off the stream that has been running the longest. This option will not interrupt a PVR recording or a VOD movie that is playing
- If the PVR is recording one or more streams and one or more TVs are tuned to live TV, then you will be given the following options. Highlight the option you want, and press **OK**
 - **STAY ON CHANNEL** – This option will keep the TV on the current channel
 - **RECORDED TV** – This option will take you to the current recordings screen of the PVR, letting you stop a recording to free up a stream for watching live TV. This option is only available at the PVR set-top box
 - **INTERRUPT A TV** – This will turn off the stream that has been running the longest. This option will not interrupt a PVR recording or a VOD movie that is playing

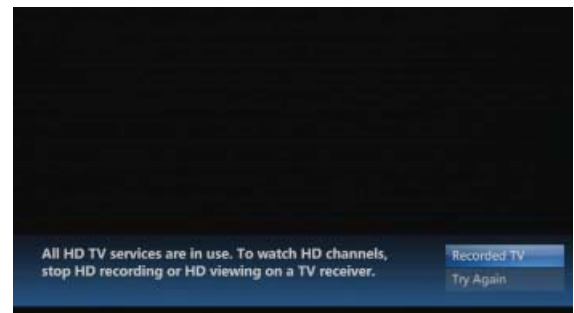

Resolving recording conflicts

The PVR can record three programs at a time. Recording conflicts occur when additional recordings are attempted.

How to resolve a single recording donflict

When an individual recording conflicts with one or more previously scheduled recordings, a Recording Conflict screen alerts you to the problem.

- To cancel recording the program that caused the conflict,
 - Highlight **DON'T RECORD** (Program Name), and press **OK**.
 - Highlight **CANCEL RECORDING**, and press **OK**
 - Or, highlight **DON'T CANCEL** and press **OK** if you do not want to cancel the recording
- To resolve the conflict by changing which programs will be recorded
 - Highlight **RESOLVE CONFLICT**, and press **OK**
 - Use the **ARROW** button to highlight which program to record and press **OK**; a red dot indicates the program is chosen for recording. The program beneath it will have the red dot removed
 - Highlight **SAVE CHANGES** and press **OK**, or **CANCEL CHANGES** to return to the Guide

Recording or clearing an overridden recording

An individual conflict icon (the crossed-out red dot) in the Guide marks an individual recording that was cancelled in favour of another recording. A series conflict icon (crossed out, three overlapping red dots) in the Guide marks a series episode that was cancelled in favour of another recording.

- Press **GUIDE**
- Use the **ARROW** buttons or **CH | PG** to highlight the overridden program (indicated by a crossed-out red dot), and press **OK**. A Program Info screen appears

The following actions are available:

- Leave it as is
- Cancel the recording
 - Highlight **DON'T RECORD** and press **OK**
 - Select **CANCEL RECORDING** to clear the conflict and cancel the recording.
 - Choose **DON'T CANCEL** , to return to the Program Info screen
- Override another recording
 - Highlight **RESOLVE CONFLICT**, and press **OK**
 - Highlight the conflicting program and press **OK**; the red dot appears to the right of the program name
 - Highlight **SAVE CHANGES** and press **OK**
 - The message “Recording Scheduled” or “Series Recording Scheduled” appears for a few seconds and the Program Info screen returns. The conflict icon reverts to a red dot.
 - Press **EXIT** to return to Live TV

MyPVR

With MyPVR you can record TV from anywhere you have an Internet connection. Set your PVR from your computer or mobile device and never miss a show. Just go to mts.ca/myaccount to schedule the recording. You can also delete recordings to free up PVR space.

MTS Video On Demand

- A list of MTS Video On Demand movies and trailers are also available at mts.ca/nowplaying. If the video is locked by parental or rental locking, enter your PIN to unlock the video. A video remains unlocked for four hours.
- Watch rented programs unlimited times within your rental window, some movies up to 48-hours.

Accessing MTS Video On Demand

- Press **MENU**
- **DOWN ARROW** to **ON DEMAND** or press the **VIDEO ON DEMAND** button
- Use the **ARROW** buttons to highlight a video category:
 - **MY VIDEOS**– Displays your current rentals, if any
 - **MOVIES** – Displays subcategories of movies, including genres
 - **SUBSCRIPTION TV** – If you subscribe to channels such as Super Channel, Treehouse TV, Showcase etc.
 - **STORIES FROM HOME** – MTS TV exclusive programs
 - **SEARCH**
 - **ADULT**

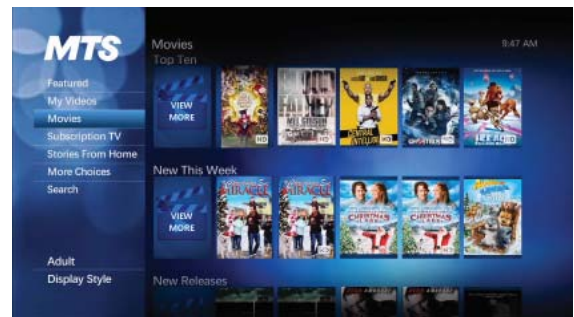

Renting MTS Video On Demand

- Use the **ARROW** buttons to highlight a genre, subcategory, or video and press **OK**
- A Video On Demand screen appears with the following options:
 - **RENT** – To purchase a video rental
 - **PREVIEW** – If available, a trailer can be previewed
 - **ADD TO BOOKMARKS**
- The video begins to play immediately. The synopsis will indicate how long the rental is available



Play Video On Demand programs

Rented videos can be played any time until it expires within the 24-hour rental window.

- Press **VIDEO ON DEMAND**
- **DOWN ARROW** to **MY VIDEOS**
- The Current Rentals screen appears
- Highlight the video, and press **OK**
- Highlight **PLAY**, and press **OK**

Controlling Video On Demand programs

You can control Video On Demand using the **PAUSE**, **PLAY**, **STOP**, **REW**, **FF**, **SKIP** and **REPLAY** buttons.

You are unsure of the expiration date for a video

Watch rented movies unlimited times within the specified timeframe noted in the movie information synopsis.

- Press **VIDEO ON DEMAND**
- The Current Rentals screen lists the rented videos
- Select **MY VIDEO** and press **OK**
- The expiration period for that video appears on the screen. When a video expires, the system deletes it from MY VIDEOS

The video expires while playing

If a video expires while being played, it stops playing.

If a rented Video On Demand program is not in the Current Rentals list

- The video probably expired
- When a video expires, it is deleted from the Current Rentals screen

MTS Pay-Per-View Events

Get front row seats to some of the best live TV events including mixed martial arts, wrestling, and other special events, without having to leave the comfort of your couch.

- Press **GUIDE** to see Pay-Per-View listings on channels 801 and 802 in SD, and 1801 and 1802 in HD

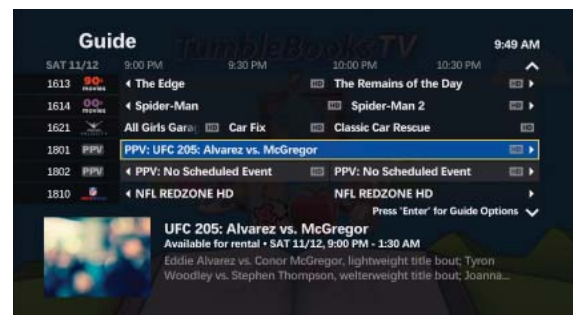

Parental & Rental Locking – VOD and Live TV

Default settings for parental locking

- MTS TV Parental Control locks are set at 18A by default
- Locked channels and programs still appear in the Guide and they can be scheduled to record, however the PIN is required to watch recorded locked programs
- A default PIN (1234) was pre-set by MTS to prevent access to adult content. The default PIN (1234) can be used to temporarily access adult content for up to 30 minutes
- For new customers, the first time you enter the Parental Controls you will be prompted to enter a new PIN. At that time all defaulted parental controls, including adult content, are removed. This includes disabling the Adult Lock that was enabled when the STB is first installed in your home

You must re-enable the Adult Lock in order to block adult content.

VERY IMPORTANT: Each TV set in your home requires Parental & Rental Locking to be setup separately, or your family and guests will be able to view restricted content and rent Video On Demand programs. Setting it up on one TV will not set it up on other TVs.

Movie and TV rating systems

Movie ratings

- **A** – Only adults may rent. Content is sexually explicit, or graphically and excessively violent
- **R** – Only adults 18 and over may view or rent. May contain many scenes of horror, violence, sexual activity or material that degrades individuals or groups
- **18A** – Youth aged 14 – 17 must be accompanied by an adult when they view or rent. Parents strongly cautioned. Will likely contain explicit violence, frequent coarse language, sexual activity and/or horror
- **14A** – Children under 14 must be accompanied by a parent or adult when they view or rent. Subject matter or language may be controversial or offensive
- **PG** – All may view or rent. However, parental guidance is advised. Most suitable for viewers over age 12
- **G** – General audiences. All ages admitted
- **E** – Exempt from rating. Includes news, sports, documentaries and other information programming, as well as talk shows, videos, music, and variety programming

TV Parental guidelines

- **A** – Adult only. Content is sexually explicit, or graphically and excessively violent
- **18+** – Adult programming, intended for viewers 18 years and older. Might contain depictions of violence, graphic language or explicit sexual activity
- **14+** – Viewers 14 years and older. Parents strongly cautioned. Might contain intense scenes of violence, possible strong or frequent profanity, nudity and/or sexual activity
- **PG** – Parental guidance suggested. Might be unsuitable for children under 13 without supervision. Might contain limited and moderate violence, mild profanity and/or suggestive language, brief scenes of nudity and/or discreet sexual references
- **G** – General programming, suitable for all audiences. Minimal violence, no profanity. No sex/nudity
- **C8+** – Acceptable for children 8 years and over to view without supervision. References to controversial subjects are subtle. Might include mild violence. No profanity, no sex/nudity
- **C** – Intended for all children, especially those under the age of 8. Depictions of aggressive behaviour are infrequent and unrealistic. No offensive language, no sex/nudity
- **E** – Exempt from rating. Includes news, sports, documentaries and other information programming, as well as talk shows, videos, music, and variety programming

Getting ready to use parental locking

- Press **MENU**
- Use the **DOWN ARROW** to highlight **SETTINGS**
- Highlight **PARENTAL CONTROLS**, and press **OK**
- Highlight **PARENTAL LOCKING**, and press **OK**
 - A default PIN has been pre-set by MTS to **1234** to prevent access to Adult Content
 - Use the **NUMERIC KEYPAD** to enter a four-digit PIN
 - If PIN is entered incorrectly, press **DELETE** to erase
 - If a PIN has already been set, enter the previously set PIN
- To lock ratings for Adult Programs, Movie Ratings, TV Parental Guidelines, Channels, Time Locking and Unrated Content use the **ARROW** button to highlight **CHANGE** and press **OK**

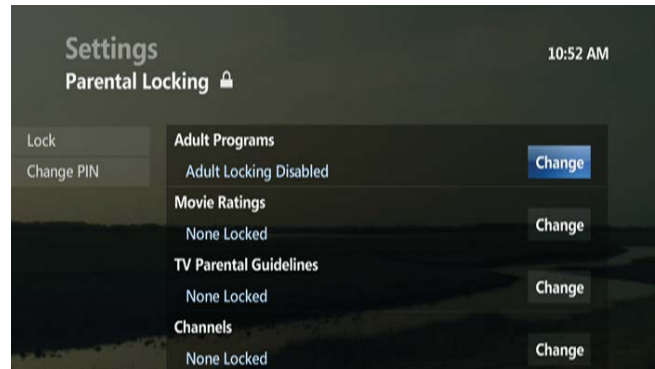

Lock adult programs

- When locked, your 4-digit PIN will be required to view adult programs
- Highlight the box and press **OK** to add or remove a lock
- Highlight **SAVE** to keep changes, or **DON'T SAVE** to cancel changes

Lock movie rating or TV parental guidelines (Block programming based on ratings)

All rating levels are displayed.

- Use the **UP/DOWN ARROWS** to move through the list, press **OK** to lock or unlock a rating
Locked ratings display a lock in the box to the left of rating
- To reset locked ratings, highlight **UNLOCK ALL**, and press **OK**. All the lock icons are removed
- Highlight **SAVE** to keep changes, or **DON'T SAVE** to cancel changes
- To finish Parental Locking, highlight **LOCK**, and press **OK**

Lock channels

All channels are listed.

- Use the **UP/DOWN ARROWS** to move through the list, press **OK** to lock or unlock a channel
Locked channels display a lock in the box to the left of channel
- **From the menu on the left the following options are available:**
- To reset locked channels, highlight **UNLOCK ALL**, and press **OK**. All the lock icons are removed
- To only show the locked channels, highlight **VIEW LOCKED ONLY**, and press **OK**. The **VIEW LOCKED ONLY**, option becomes **VIEW ALL CHANNELS**
- Highlight **SAVE** to keep changes, or **DON'T SAVE** to cancel changes

Lock by time

Days of the week are listed.

- Use the **UP/DOWN ARROWS** to select a day to set time locking, highlight **CHANGE**, press **OK**
- Use the **UP/DOWN ARROWS** to select the block of time to lock, press **OK** to lock or unlock the half-hour block of time. Locked period will display a lock in the box to the left of the time block
- **From the menu on the left the following options are available:**
- Highlight **SAVE** to keep changes, or **DON'T SAVE** to cancel changes
- To lock the entire day, highlight **LOCK ALL**, and press **OK**. All blocks of time will display the lock icon. The **LOCK ALL** option becomes **UNLOCK ALL**

- To unlock the entire day, highlight **UNLOCK ALL**, and press **OK**. All blocks of time will now have the lock icons removed
- To show only the locked time blocks for the day, highlight **VIEW LOCKED ONLY** and press **OK**. The **VIEW LOCKED ONLY** option becomes **VIEW ALL**
- To copy the same settings to all other days, select **APPLY TO ALL DAYS**, and press **OK**. Highlight **YES** or **NO** to confirm
- To enable Time Locking, select the Time Locking box and press **OK**, a lock icon will display. Highlight **SAVE** to keep changes or **DON'T SAVE** to cancel changes
- To disable Time Locking, select the Time Locking box and press **OK**, the lock icon will be removed. Highlight **SAVE** to keep changes

Lock unrated

- The message “Lock Unrated Programming – Some programs, such as educational TV shows and movies released before 1960 are not rated” appears
- Highlight the box and press **OK** to add or remove a lock
- Highlight **SAVE** to keep changes, or **DON'T SAVE** to cancel changes

Watching a locked program

- When scrolling through the Guide or channels on live TV, locked programs display a lock image in the picture-in-picture tile
- To access a locked program, select the channel and press **OK**
- The screen fills with the lock image with the message “Press OK to Unlock”, press **OK**
- The message “Enter your 4-digit PIN to unlock” appears. Using the **NUMERIC KEYPAD** enter the four-digit PIN
- The option to **DON'T UNLOCK** and **UNLOCK** are displayed, highlight and press **OK**

Rental locking

Rental locking blocks household members from purchasing Pay-Per-View or Video on Demand Movies. A monthly spending limit is set to \$100 for both MTS Pay-Per-View and MTS Video On Demand.

- Press **MENU**
- Press the **DOWN ARROW** button to highlight **SETTINGS**
- Highlight **PARENTAL CONTROLS**, and press **OK**
- Highlight **RENTAL LOCKING**, and press **OK**
 - A default PIN has been pre-set by MTS to **1234**
 - Use the **NUMERIC KEYPAD** to enter a four-digit PIN
 - If PIN is entered incorrectly, press **DELETE** to erase
 - If a PIN has already been set, enter the previously set PIN
- To lock rentals, press the **RIGHT ARROW** to highlight **RENTAL LOCKING**, and press **OK**
- **RIGHT ARROW** to highlight the checkmark **LOCK RENTING** selection box
- Press **OK** and the lock renting icon appears in the box
- To unlock rentals, press **OK** again to clear the lock icon
- Highlight **SAVE**, and press **OK**, or select **DON'T SAVE** to exit from this screen without saving changes

Changing the PIN

- Press **MENU**
- Press the **DOWN ARROW** to highlight **SETTINGS**
- Highlight **PARENTAL CONTROLS**, and press **OK**
- Highlight **PARENTAL LOCKING**, and press **OK**
- Enter the four-digit PIN
- Use the **ARROW** buttons to highlight **CHANGE PIN**, and press **OK**
- Use the **NUMERIC KEYPAD** to enter a four-digit PIN, and then enter the PIN again to confirm it. To change parental locking settings, you must specify a new PIN
- Highlight **LOCK**, and press **OK**

Forgot your Parental Control PINs?

- First-time subscribers have PINs set to **1234**
- Check to ensure the correct PIN was used. For example, was a parental-control PIN used to rent a movie or was a rental PIN used to view adult content?
- Check with other members of the home if the PIN was reset
- Has someone who is not supposed to have access to the PIN, set or reset the PIN
- If the PIN must be reset, contact MTS at 204-225-5687

Parental Control tips

Rental Locking is in effect even when Parental Locking is temporarily turned off

After Rental Locking is set up, it remains in effect even if Parental Locking is temporarily turned off. You can watch any program without entering a parental control PIN during the suspension period, but you must still enter a PIN to rent videos and other content.

Cannot prevent the recording of locked content

Locked content can be recorded without entering a PIN. However, a PIN is required to view recorded locked programs.

Parental locking can be applied to recordings even after a program has been recorded.

For example, if an R-rated movie is recorded before parental locking is in effect, and then a lock is applied to R-rated content, you cannot view the R-rated recording without entering the correct PIN.

Children can view a hidden channel

Hiding a channel does not lock the channel.

Hiding a channel by using the Customize Channels screen makes the channel invisible in the program Guide as well as when using the channel/page (**CH | PAGE**) button.

The channel can be viewed if it is directly tuned to by entering the channel number.

To lock a channel use the **PARENTAL LOCKING** settings.

Apps on TV

We are constantly adding new apps to our TV service. Check mts.ca/ultimatetv for the most up-to-date list. To access Apps on TV you must also subscribe to MTS High Speed Internet service (any plan other than Light and Super Max). Visit our Apps on TV demo channel (channel 96) to try out our apps.

MyPicks

MyPicks lets you enhance your TV viewing experience! Customize your viewing experience and keep track of up to six channels of your choice at one time on one screen.

Note: A maximum of five Picks can be created per household.

Creating your first MyPick

*User Tip: Press the **A** BUTTON at any time for help information.*

- Tune to channel **93** and press **OK**
- Use the **UP/DOWN ARROWS** to select **CREATE A PICK** and press **OK** to launch the MyPicks Wizard. If you select **DON'T CREATE A PICK** instead, you will return to the last channel viewed
- Use the **UP/DOWN ARROWS** to highlight the layout style you want and press **OK**. Then use the **RIGHT ARROW** to highlight the on-screen **NEXT** arrow and press **OK**
- Use the **UP/DOWN ARROWS** to highlight the layout you want and press **OK**. Then use the **UP/DOWN** buttons to highlight the on-screen **NEXT** arrow and press **OK**
- Use the **CH | PG** button to scroll through pages of available channels and the **UP/DOWN** buttons to highlight the channel you want. Press **OK** to add or remove channels and use the **RIGHT ARROW** to highlight the on-screen **NEXT** arrow and press **OK**
- Use the **CH | PG** button to scroll through pages of available channels and the **UP/DOWN** buttons to highlight the up or down indicator next to a channel. Press **OK** to move the selected channel and use the **RIGHT ARROW** to highlight the on-screen **NEXT** arrow and press **OK**
- Use the **ARROW** button to highlight characters on the keyboard and press **OK** to select the characters you want (to a maximum of ten). Use the **RIGHT ARROW** to highlight the on-screen **NEXT** arrow and press **OK**
- You will be presented with a confirmation page indicating that your Pick has been successfully saved and then automatically navigated to the Landing Page

*Press the **A** button at any time for help information.*

*Press the **BACK** button on your remote at any time to return to the previous screen.*

*Press the **EXIT** button on your remote at any time to exit MyPicks.*

How to view an existing MyPick

- Tune to channel **93** and press **OK**
- Use the **ARROWS** to select from the list of existing Picks and press **OK** to view
- Press the **BACK** button on your remote at any time to return to the previous screen
- Press the **EXIT** button on your remote at any time to exit MyPicks



Ultimate Picks

Ultimate Picks lets you keep track of up to six shows at once within a genre! Choose from a selection of genres right on your TV screen like Kids, Movies, and Sports.

- Tune to channel **92** and press **OK**
- Use the **ARROWS** to select from the following genres and press **OK** to view: Kids, Sports, HD, Movies, and Premium Movies
- For Movies Picks, scroll through your catalogue of PIPs (picture-in-picture) using the **ARROWS**. To select a channel for viewing in full screen, highlight the **PIP** and press **OK**
- For Premium Movies Picks, scroll through your catalogue of PIPs using the **ARROWS**. To select a channel for viewing, highlight the **PIP** and press **OK**



Press the **BACK** button on your remote at any time to return to the previous screen.

Press the **EXIT** button on your remote at any time to exit Ultimate Picks.

To view a locked channel within a Pick, go to the **MENU**, select **PARENTAL CONTROLS** and modify your **PARENTAL LOCKING** settings.

Press the **A** button at any time for help information.

On-TV messages

MTS *Ultimate TV* 'Entertainment News' and 'TV Service' message notifications will show up on your TV. A small window will pop-up in the lower right corner of your TV screen, indicating you have been sent a message.

- To immediately view the message, select **READ** and press **OK**.

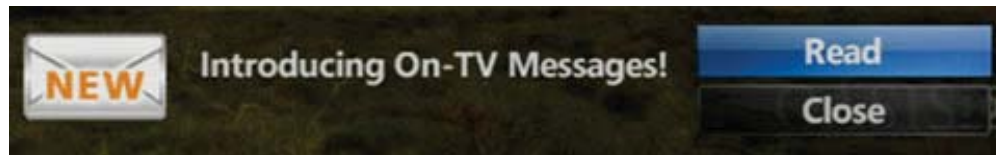

User Tip: If you CLOSE the notification pop-up, you can read the message later in the News Log

How do I access messages in the Service and News log?

- Press **MENU** on your MTS TV remote control
- Press the **DOWN ARROW** to navigate to **EXTRAS**, and press **OK**
- Press the **RIGHT ARROW** to navigate to **NEWS LOG**, and press **OK**
- The **SERVICE AND NEWS** log will be displayed. The last message received will be at the top of the list
- To view a message, use the **ARROW** keys to select a message and press **OK**. If there is more than one page to view, use the **ARROWS** on your remote to select **NEXT PAGE** or **PREVIOUS PAGE** and press **OK**
- To exit the log, press **OK**

How do I disable entertainment news pop-up notifications on my TV?

NOTE: Disabling "entertainment news" does not disable "TV service" notifications from appearing on your TV. Pop-up entertainment news notifications will be initially turned on (enabled) for all set-top boxes.

To turn the notifications off (disable), follow these steps:

- Press the **MENU** button on your MTS TV remote control
- Press the **DOWN ARROW** button to navigate to **MESSAGE CENTRE**, and press **OK**
- Press the **RIGHT ARROW** button to navigate to **NEWS OPTIONS**, and press **OK**
- Use the arrow buttons to navigate to **OFF**.
- Use the arrow buttons to navigate to **SAVE** and press **OK**
- This will disable pop-up notifications for entertainment news on every TV (set-top box) in the house.

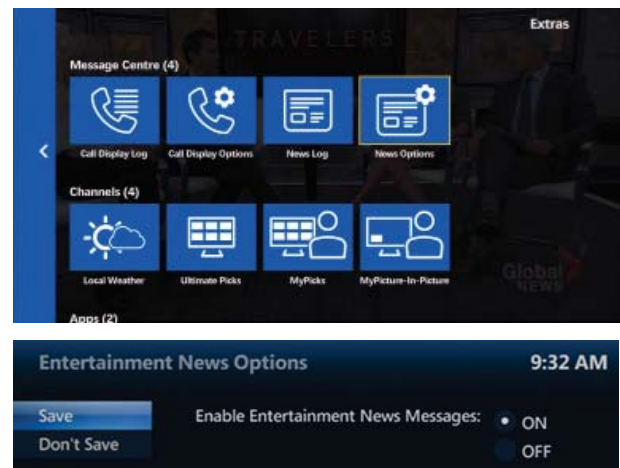

How do I delete messages in the Service and News log?

You don't need to delete messages because they will expire automatically after a pre-set amount of time.

How do I know which messages in the log have been viewed?

The read / unread status of the messages are easy to see:

- Messages that have been read will have an “open” envelope icon
- Messages that have not yet been read will have a “new” envelope icon



Service and News Log			10:14 AM
	Service Message	Introducing On-TV Messages!	Jun 17, 12:00 AM
	Entertainment News	July Channel 30 Freeviews	Jun 01, 12:00 AM
	Entertainment News	June Channel 30 Freeviews	May 10, 12:00 AM
	Service Message	Upgrade for TV Service	May 09, 12:00 AM

Purchasing Add-Ons

MTS TV will let you know when there is an opportunity to purchase ‘add-ons’, such as specialty channels, through your TV. A ‘Buy Now’ option will appear whenever you select such a channel. To complete the purchase, enter your 4-digit pin. This is the same PIN used to order MTS Video On Demand.

Remote Controls

There are 5 remote controls for *Ultimate TV* service. Each remote has slightly different buttons and different programming instructions, but the buttons on each remote operate in the same way.



Look for the **LEARN** button

MXv3
Black Remote
(no MTS logo)



Silver or Charcoal



Look for the Motorola symbol on back



RF remotes come with a converter

MXv3 RF
Black Remote



MXv4
Black Remote
(with MTS logo and writing on back)



MXv4 RF
Black Remote

How to program your remote control



Getting started

Install batteries in your remote control

- The remote control requires two AA-size alkaline batteries (1.5V) batteries
- On the back of the remote, push down on the tab and lift off the cover
- Match the batteries to the + and - marks inside the battery case, then insert two AA alkaline batteries
- Press the battery cover back into place
- Test the remote control by pressing the STB/MTS key. The STB/MTS key should light up if the batteries are properly inserted

User Tip: For the MXv4 (RF) remote, the mode Key (TV, DVD or AUX) will blink 5 times with each key press when batteries need replacement.

Program your MTS Ultimate TV remote to control your TV, DVD, Home Theatre receiver, or other devices

You can program your MTS TV Remote to control other devices using the **TV**, **DVD**, and **AUX** mode keys.

User Tip: The DVD and AUX mode keys can be setup with codes for any type of equipment. The TV mode key can only be setup with TV codes. If you have a combination unit, such as a TV/DVD unit, each component of the unit will normally be programmed separately.

Manually program the TV, DVD, or AUX mode keys using direct code entry

Black MXv4 (RF) Remote Only:

1. Power on the device you want to program. Locate the 4-digit set up code for the device you want to program from the Manufacturer Code List
2. Press the appropriate mode key (TV, DVD, or AUX) on the remote control
3. Press and hold **SETUP** until the mode key blinks twice
4. Enter the first code for your brand from the code list using the number pad on the remote control
5. Press the **POWER** key to test with your device. If the device does not turn off, repeat steps 3-5 using the next code for your brand of device
6. Repeat the steps to program another device

Black MXv3 (RF) Silver and Charcoal Remotes Only:

1. Power on the device you want to program. Locate the 4-digit set up code for the device you want to program from the Manufacturer Code List
2. Press and hold the appropriate mode key (TV, DVD, or AUX) on the remote control
3. Enter the first code for your brand from the code list using the number pad on the remote
4. Press the **POWER** key to test with your device, if the device turns off, setup is complete
5. If the device does not turn off, repeat steps 3-5 using the next code for your brand of device
6. Repeat the steps to program another device

Program the TV, DVD, or AUX mode keys for ten popular brands of equipment

Black MXv4 (RF) remote only:

1. Power on the device you want to program. Locate the 4-digit set up code for the device you want to program from the Manufacturer Code List
2. Press and hold **SETUP** until the mode keys blink twice
3. Press the mode key (**TV**, **DVD**, or **AUX**) for the device you wish to set up. The selected mode key should stay lit
4. Find your device and brand from the charts below and note which number key is assigned to your brand. If your brand is not listed in the following chart, then try the Direct Code Entry or the **SETUP** key
5. Press and hold the number key assigned to the brand of device you are trying to program
6. Release the key when your device turns off. Setup for that device is complete
 - 2 Blinks of the TV, DVD, or AUX mode key = Success
 - 1 Long Blink of the TV, DVD, or AUX mode key = Failure

Remote Control Number Key	TV Brands	DVD/VCR Brands	Audio Brands
1	Insignia/Dynex	LG	Bose
2	LG	Memorex	Denon
3	Mitsubishi	Panasonic	LG
4	Panasonic	Philips/Magnavox	Onkyo
5	Philips/Magnavox	RCA	Panasonic
6	Samsung	Samsung	Philips
7	Sharp	Sharp	Pioneer
8	Sony	Sony	Samsung
9	Toshiba	Sylvania	Sony
0	Vizio	Toshiba	Yamaha

Program the TV, DVD, or AUX mode keys using the Code Search

If you can't find a 4-digit code for your device, try using the search function.

Searching on the black MXv3 remotes cannot be performed for any mode key until after that mode key is set-up with a valid code. So, select any code for the appropriate mode from the code list, program the key using section A, and then follow the steps below. For example if you're trying to program a DVD player to the DVD key, but you don't have the code, program any DVD code from the list to the DVD key using the steps in section A, then you can follow the steps below.

Black MXv4 (RF) remote:

1. Turn on the device you want to control and point the remote at that device
2. Press and hold **SETUP** until the mode key blinks twice
3. Press the mode key for the device you wish to setup. The mode key stays lit
4. Press and hold the **OK** key
5. Release the **OK** when your device turns off

Black MXv3 (RF) remote:

1. Turn on the device you want to control and point the remote at that device
2. Press and hold the mode key (i.e. **TV**, **DVD**, or **AUX**) you want to program
3. Without releasing the selected mode key (i.e. **TV**, **DVD**, or **AUX**), press and hold the **OK** key simultaneously
4. Release both the mode key (i.e., **TV**, **DVD**, or **AUX**), and the **OK** key – all of the mode keys will flash, then the selected mode key light will stay lit
5. Press the power button repeatedly until the selected device turns off. Once your device has turned off, press **OK** to save the code
6. To indicate a successful setup, the selected mode key will turn off and you are ready to setup another device by following steps 1 thru 4 of this section

Silver/Charcoal remote:

1. Turn on the device you want to control and point the remote at that device
2. Press and hold the mode key (i.e. **TV**, **DVD**, or **AUX**) you want to program
3. Without releasing the selected mode key (i.e. **TV**, **DVD**, or **AUX**), press and hold the **OK** key simultaneously
4. Release both the mode key (i.e. **TV**, **DVD**, or **AUX**), and the **OK** key – all mode keys will flash twice indicating programming mode
5. Enter **922** by pressing the number keys on the remote control
 - a. The selected mode key (**TV**, **DVD**, or **AUX**) will flash twice indicating correct entry
 - b. For **AUX** searching only, press and release the **PLAY** key then press:
 - 1 for VCR
 - 2 for Receiver/Tuner
 - 3 for Amplifier
 - 4 for Home Theatre in the Box (HTIB)The AUX mode key will flash twice indicating correct entry
6. Press and hold **PLAY** key and wait until the device turns off, then release the **PLAY** key
 - a. The **REW** key can be used to go back through the codes one at a time
 - b. The **FF** key can be used to move forward through the codes one at a time
7. To save the code press the **ENTER** key on the remote control or press the **EXIT** key to return to normal operation. The selected mode key will flash three times and return to normal operation
8. If no valid code is found, the green backlight will flash twice and the remote control will return to normal operation
9. Turn the device back on and use the remote to control your device. Now that your devices are programmed you can press the appropriate mode key on the remote control to work with the selected device. To use the remote control for your Set Top Box again, press the **STB/MTS** mode key

User Tip: You may need to repeat steps 1 through 8 to find a code.

Note: If any other key is pressed except **PLAY**, **ENTER**, **POWER**, **EXIT**, **REW**, **FF** or number keys **1** to **4** the selected mode key will give a long red flash (error message) and the remote control will return to normal operation and you will need to start over.

If you are interrupted while you are programming, the remote control may time-out before you complete the code setup and you will need to start over. A remote time out is indicated by two quick flashes of the green backlighting.

Power control for multiple devices

By default, the **POWER** key only powers **ON** or places your set-top box in Standby mode. If you program the **TV** mode key then the TV and Set Top Box can both be powered **ON/OFF** simultaneously.

You also have the option to turn **ON/OFF TV**, **DVD**, or **AUX** mode devices individually by pressing the applicable mode key then the **POWER** key.

Learning (Black remotes only)

If the search method doesn't find the code for your device, you can use the existing remote from your device to "teach" your MTS *Ultimate TV* remote how to control that device.

Learning commands

Black MXv3 (RF) Remote:

Learning cannot be performed for any mode until after that mode is setup with a valid code. So, to learn the keys, first setup the mode with a valid code (see section A, "select any code for the appropriate mode, from the code list"), then follow these steps:

1. Press and hold the mode key (**TV**, **DVD**, or **AUX**) on the MTS TV Black remote and while holding it pressed, press the **LEARN** key for one second then release both keys
2. All of the mode keys will flash and then the selected mode key light remains on
3. On your MTS TV black remote, press and release the key that you want to teach.
4. While pointing your original remote at the bottom of your MTS TV Black remote, approximately 1 inch apart, press and hold the original remote key until the mode key light blinks once and stays on (If there is a learning problem, the mode key light blinks for three seconds and stays on. If this happens, repeat steps 3 and 4 above)
5. Repeat steps 3 and 4 for each key you want your MTS TV black remote control to learn
6. Press and release the **LEARN** key when all desired remote commands have been learned. If you have encountered difficulties with the **LEARN** key setup, please refer to "Troubleshooting Learning"

NOTE: It is not necessary to have your MTS TV black remote control learn every key from your original remote since most keys won't be used under normal daily use. The best practice is to teach only the keys that help you navigate for the best experience, like your volume up and down, channel up and down, and PVR functions.



Black MXv4 (RF) with MTS logo remote:

1. Position your MTS TV remote 1-2 inches away from the device remote. Make sure the infrared ends of the remotes are pointed toward each other.



MXv4 Remote (RF)



Your original remote

2. Press and hold **SETUP** until the LED lights blink twice
3. Press **975** on the number key pad
4. Press the desired mode key on the MTS TV remote (**TV**, **DVD**, or **AUX**) for the device you wish to set up, then the key on the MTS remote that you want to teach
5. Press and hold the desired key on the teaching remote until the mode key on the MTS TV remote blinks twice
6. Repeat steps 2-5 to learn other keys from the original device remote
7. To exit learning mode, press and hold **SETUP** until a mode key blinks twice

Troubleshooting learning (Black MXv3 & MXv4 remotes only)

- No functions may be stored under the **LEARN/SETUP** key, or in the **STB/MTS** mode
- Depending on the remote you are trying to learn from, some keys may not be teachable
- Only one original device type can be learned per individual mode
- Use fresh batteries for your original remote, and your MTS TV remote control
- Keep at least three feet away from incandescent or low energy lights when learning
- Point your original remote so the infrared elements on both remotes are directly in line with each other. You may need to adjust the height of the remotes to achieve this
- If you keep experiencing errors while learning the first or second keys for a mode, then try the following:
 - End the learn session by pressing the **LEARN/SETUP** key
 - Clear out the learned commands for that mode
 - Check the infrared elements of the two remotes are correctly aligned
 - Change the distance between the two remotes to be either closer (half an inch) or further away (2 inches) from each other

Try learning the original remote for that mode again. If problems reoccur with the same key, check the original remote key being learned – does it transmit? Does it operate the target device?

Try learning that key under a different clear mode. If it learns, then it is likely a different code type from the others and cannot be learned under the same mode.

Set volume options for multiple devices

The default setting for your power, volume, and channel control are to control your MTS TV set-top box regardless of the mode you are in. For example, even in DVD mode, the volume will still control the set-top box.

Volume control set up options for multiple devices

- The volume commands are sent to the set-top box unless the TV mode key has been programmed
- If the TV mode key has been programmed, the volume commands are sent to the TV from all mode keys
- If you'd like the volume commands to be sent to just one device – for example, to your home theatre set up and not to the MTS TV set-top box or TV set – follow the instructions in Lock the Volume Controls to One Device
- If you'd like the volume command sent to different devices depending on which mode you are in, go to Volume Control Depends on Device Selected

Lock the volume controls to one device

Silver/charcoal remote:

1. Press and hold the **STB/MTS** key and hold the **OK** key simultaneously on the remote control
2. Release both the **STB/MTS** key and the **OK** key – all the mode keys will flash twice indicating programming mode
3. Enter **955** by pressing the number keys on the remote control – the **STB/MTS** key will flash twice indicating correct entry
4. Press the mode key (**TV**, **DVD**, or **AUX**) that you want to always receive the volume commands. The selected mode key will flash three times indicating successful assignment and return to normal operation

The volume commands will now go to the selected device no matter what mode you are in

Black MXv3 (RF) remote:

1. Press the **TV** key and while holding it pressed, press the **OK** key for 1 second
2. Release both keys, all of the mode keys will flash followed by the TV mode key light remaining on
3. Press and hold the **MUTE** key for 3 seconds until the **TV** mode key light briefly turns off then remains on. Press and release the mode key you want to always operate the volume commands (**STB/MTS**, **TV**, **DVD**, or **AUX**). The selected mode key light will remain on
4. Press and release the **MUTE** key to save the setting. The selected mode key light will turn off indicating a successful setup. The volume commands will be setup for the selected device regardless of the selected mode. If the selected mode key light flashes for 3 seconds and turns off, then the selected mode will have no volume commands of its own and will need to start over from step 1 above and select a different mode to program the device

Black MXv4 (RF) with MTS logo remote:

1. Press and hold **SETUP** until the mode key blinks twice
2. Press the **VOL +** key
3. Press the mode key (**TV**, **DVD**, or **AUX**) that corresponds to the device you use for volume controls
4. 2 blinks = success; 1 long blink = failure

Volume Control depends on device selected

The volume setting can also be reconfigured to independently control the volume associated with each device (e.g. In **AUX** mode the receiver controls the audio; in **TV** mode the TV controls the audio).

Silver/charcoal remote:

1. Press and hold the **STB/MTS** key and hold the **OK** key simultaneously on the remote control
2. Release both the **STB/MTS** key and the **OK** key – all the mode keys will flash twice indicating programming mode
3. Enter **955** by pressing the number keys on the remote control – the **STB/MTS** key will flash twice indicating correct entry
4. Press the **ENTER** key – the **STB/MTS** key will flash three times indicating successful assignment and return to normal operations

Black MXv3 (RF) remote:

1. Press the **TV** key and while holding it pressed, press the **OK** key for 1 second
2. Release both keys, all of the mode keys will flash followed by the TV mode key light remaining on
3. Press and hold the **MUTE** key for 3 seconds until the **TV** mode key light briefly turns off then remains on, then release the **MUTE** key
4. Press and release the **MUTE** key to save the setting. The **TV** mode key light turns off indicating successful setup. The volume commands will now work for different devices

NOTE: If a programmed mode key has no volume commands of its own, then the volume control will normally operate the TV. If an invalid key is pressed, the selected mode key light flashes for 3 seconds and turns off. The remote control returns to normal operation and you will need to start over.

If no key is pressed within 30 seconds, the remote control times out, the selected mode key light flashes for 3 seconds and turns off. The remote control returns to normal operation at which time you can start over.

Black MXv4 (RF) with MTS logo remote:

To cancel Volume Control Lock to a single device:

1. Press and hold **SETUP** until the mode key blinks twice
2. Press the **MUTE** key
3. The mode key (**TV**, **DVD**, or **AUX**) will blink 4 times upon successful unlock

Reset the remote

To restore the factory default settings

Silver/charcoal remote:

1. Press and hold the **STB/MTS** key and hold the **OK** key simultaneously on the remote control
2. Release both the **STB/MTS** key and the **OK** key – all four mode keys will flash twice indicating programming mode
3. Enter programming code **900** by pressing the number keys on the remote control – the **STB/MTS** key will flash three times indicating you have successfully entered the code and the remote has been reset to the factory default settings

Note: If any other key is pressed except the number keys the **STB/MTS** key will give a long red flash and the remote control will return to normal operation. Should the remote control time-out before you complete the procedure you will need to start over.

Black MXv3 (RF) remote:

1. Press the **TV** key and while holding it pressed, press the **OK** key for 1 second and release both keys at the same time
2. All the mode keys will flash and the **TV** mode key light will stay on
3. Press and hold the **DELETE** key for 3 seconds until the **TV** mode key blinks and stays off. The remote control is now reset to factory default settings. If you want to use the remote control for your TV and other devices, you will need to setup the **TV**, **DVD**, and **AUX** mode keys
4. If no key is pressed within 30 seconds, the remote control times out. The selected mode key light flashes for 3 seconds and turns off. The remote control returns to normal operation and you will need to start over

Black MXv4 (RF) with MTS logo remote:

1. Press and hold **SETUP** until the LED blinks twice
2. Press **981** on the number pad and the LED will blink 4 times
3. The mode key (**TV**, **DVD**, or **AUX**) will blink 4 times upon successful unlock

Connections and Devices

Connecting the MTS *Ultimate TV* set-top box

Before moving or changing components, disconnect the power cord from the MTS *Ultimate TV* set-top box and other components. Set-top boxes with hard drives and those without hard drives have identical front panels and rear panel connectors; only the size varies.





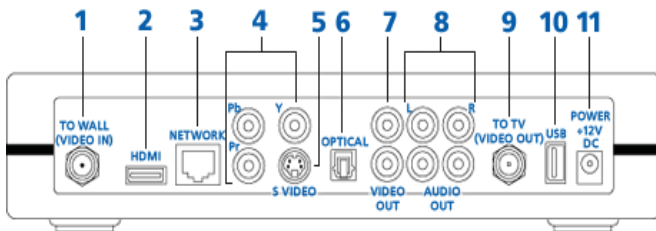

Ultimate TV has two PVRs (set-top boxes) – VIP 2262 and VIP 1216. Set-up instructions for both are included here.

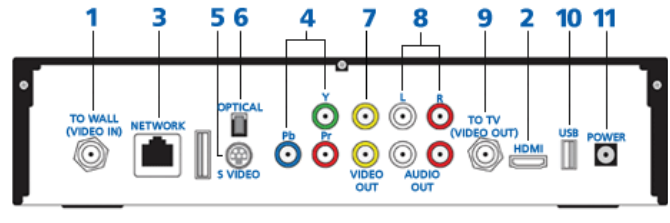
VIP 1216 PVR (160GB Hard Drive)

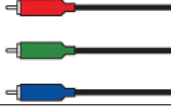

VIP 2262 PVR (160GB or 500GB Hard Drive)



Key	Item	Function	Cable Ends
1	TO WALL (VIDEO IN)	Coaxial input for home video network (HPNA)	
2	HDMI	Connects to a high-definition TV or home theatre receiver with an HDMI input (for a DVI input, use an HDMI-to-DVI adapter)	
3	NETWORK	Ethernet 10/100 Base-T RJ-45 port	
4	Y PB PR	RCA-type component video outputs to an HDTV	
5	S-VIDEO	High quality video output to a VCR or TV that accepts S-Video. It carries video only; you must also connect to the TV or home theatre receiver for audio	
6	OPTICAL	S/PDIF audio output to a digital home theatre receiver	
7	VIDEO OUT	RCA-type video outputs to a TV, VCR, DVD recorder, or other device	
8	AUDIO OUT L and R	Left and right RCA-type stereo audio outputs	
9	TO TV (VIDEO OUT)	Coaxial output to a TV or VCR	
10	USB	USB 2.0 connector	
11	POWER +12V DC	Connector for the DC power adapter	

Video connection options

The set-top box offers the following video outputs:



- **HDTV** – HDMI or Y Pb Pr (component video)
- **Standard TV** – S-Video, RCA-type, or RF coaxial

To determine the available inputs on your TV, check the TV manual or on the TV itself. When you are familiar with the available inputs on your TV, choose the optimal video connection based on the following guidelines.

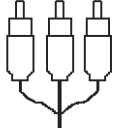
Connecting to an HDTV, use *one of*:

Best	<p>HDMI</p> 	Video and audio	<p>HDMI offers higher quality than component video. If your HDTV has an HDMI input, use the HDMI connector. HDMI carries video and audio. If you connect your HDTV using HDMI, no additional audio connection to the TV is needed.</p> <p>If your HDTV has DVI input, you can use an HDMI-to-DVI converter cable to connect to a set-top box HDMI connector. Use a cable with an HDMI connector on one end and a DVI connector on the other end. We do not recommend using an HDMI-to-DVI or DVI-to-HDMI adapter. Because DVI does not carry audio, a separate audio connection is required for DVI TV.</p>
Good	<p>Y Pb Pr</p> 	Video only	<p>The Y Pb Pr connectors provide component video for the most widely supported HDTV connection. If your HDTV only has Y Pb Pr inputs, use these connectors.</p>

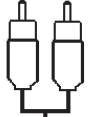
Connecting to a standard TV, use *one of*:

Best	<p>S-Video</p> 	Video only	<p>This is the highest quality standard video output. If your standard TV has an S-Video input, connect it to the S-VIDEO output on your set-top box using an S-Video cable.</p>
Very Good	<p>RCA-type</p> 	Video only	<p>If your standard TV does not have an S-Video input, connect it to the VIDEO OUT connector on your set-top box using a RCA-type video cable.</p>
Good	<p>RF coaxial</p> 	Video and audio	<p>If your TV only has a coaxial RF input, use a coaxial TO TV (VIDEO OUT) connector</p>

Audio connection options

To connect your TV or home theatre receiver for audio you can use one of the following audio options depending on its capabilities:

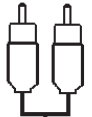
Best	<p>Optical</p> 	<p>If possible for your TV or home theatre receiver, use the OPTICAL output to deliver S/PDIF Dolby® audio. In most cases, it offers better quality, including support for Dolby Digital 5.1 surround sound.</p>
Good	<p>Audio L and R</p> 	<p>If your TV or home theatre receiver has no S/DIF input, use the RCA-type AUDIO outputs to your TV or home theatre receiver.</p>

Connect to an HDTV – Video only

- To determine your best connection, refer to Video Connection Options
- If you are connecting to a DVI or Y Pb Pr input on your TV, a separate audio connection is required. Refer to Connect to an HDTV – Audio Only
- If you are connecting to a home theatre receiver, refer to Connect to a Home Theatre – Audio Only

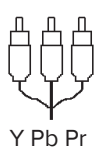

VIP 1216 PVR

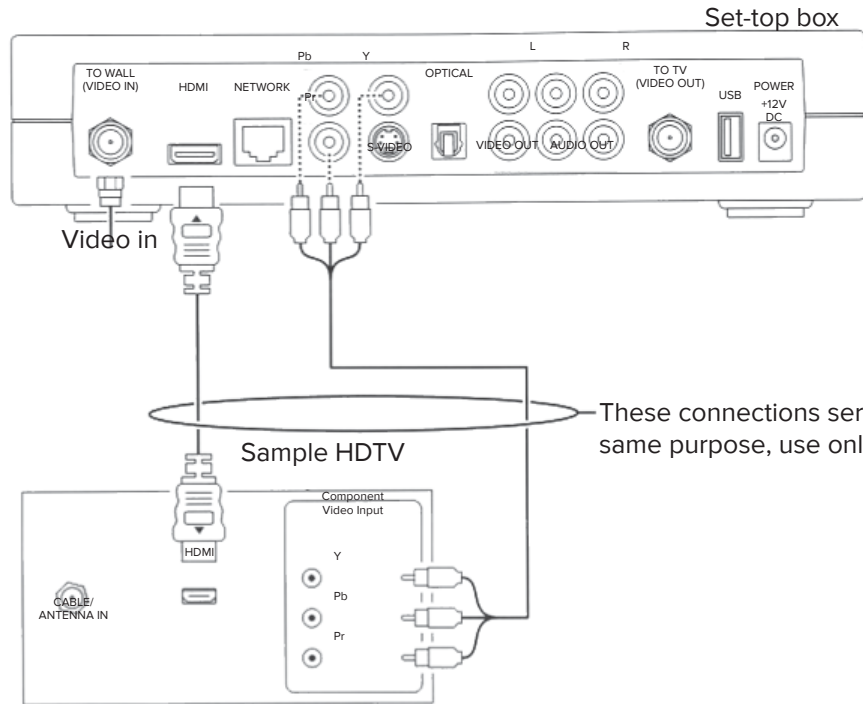

VIP 2262 PVR – Option 1

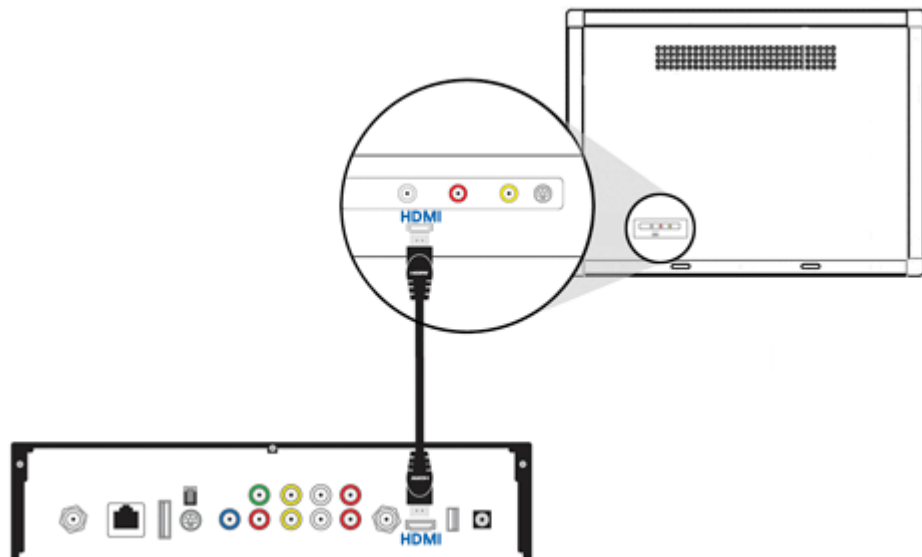

VIP 2262 PVR – Option 2

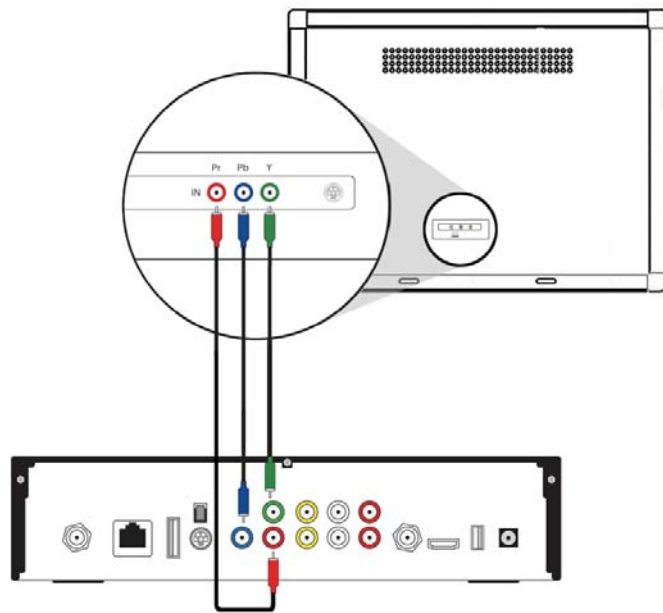

Connect to an HDTV – Audio only

- To determine your best connection, refer to Video Connection Options.
- If you are connecting to a DVI or Y Pb Pr input on your TV, a separate audio connection is required. Refer to Connect to an HDTV – Audio Only
- If you are connecting to a home theatre receiver, refer to Connect to a Home Theatre – Audio Only

VIP 1216

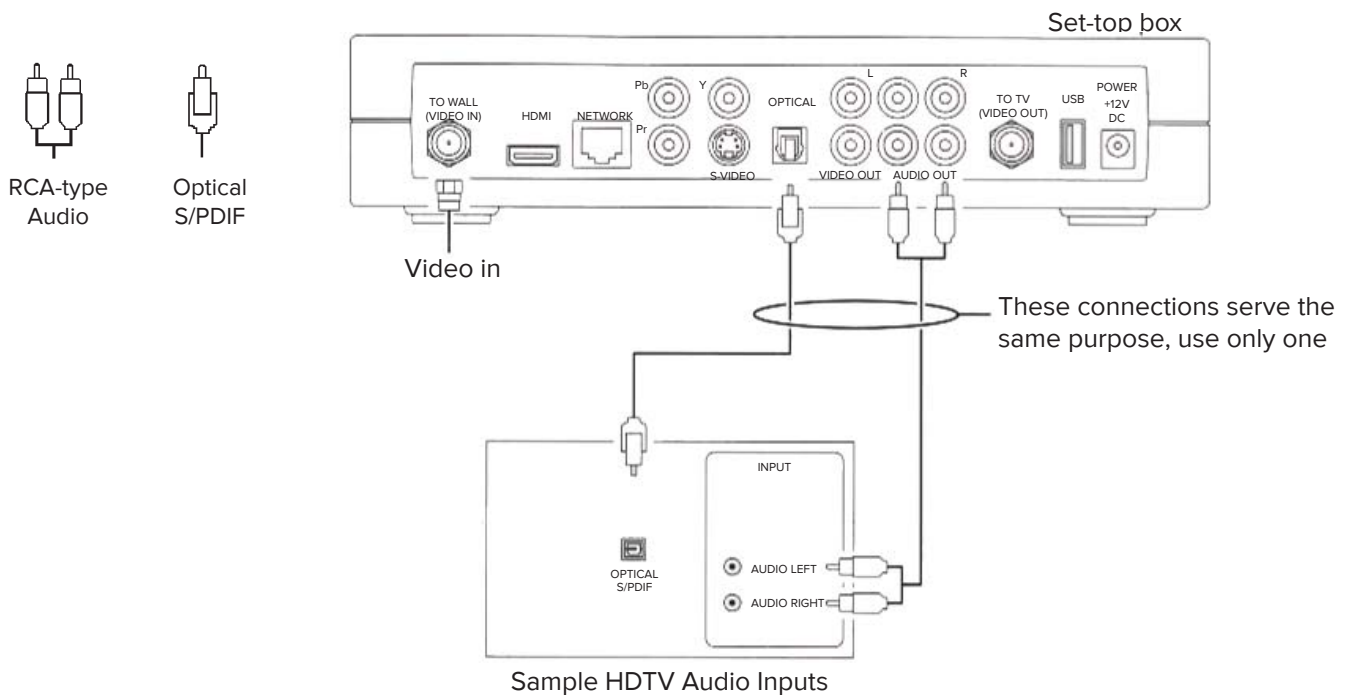

VIP 2262

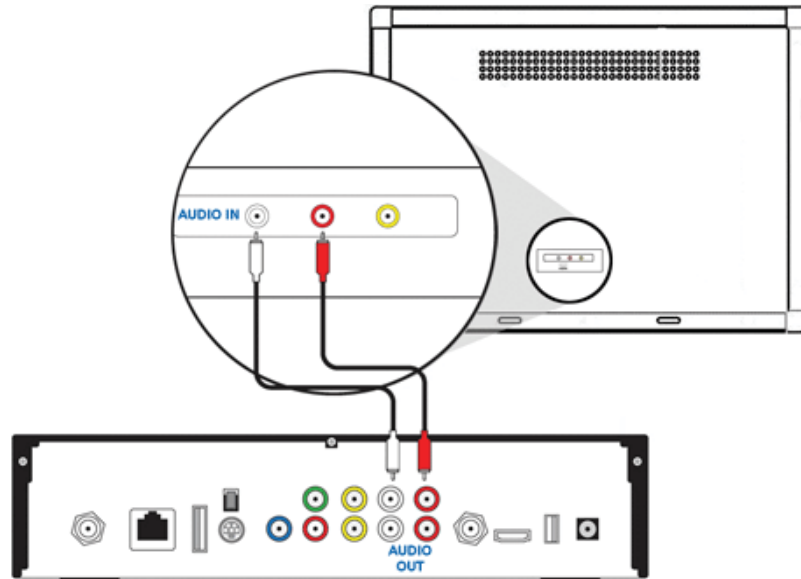

Connect to a home theatre receiver – Audio only

- To determine your best connection, refer to Audio Connection Options
- This video connection method does not support HD video. For more information, see Connect an HDTV – Audio Only

VIP 1216

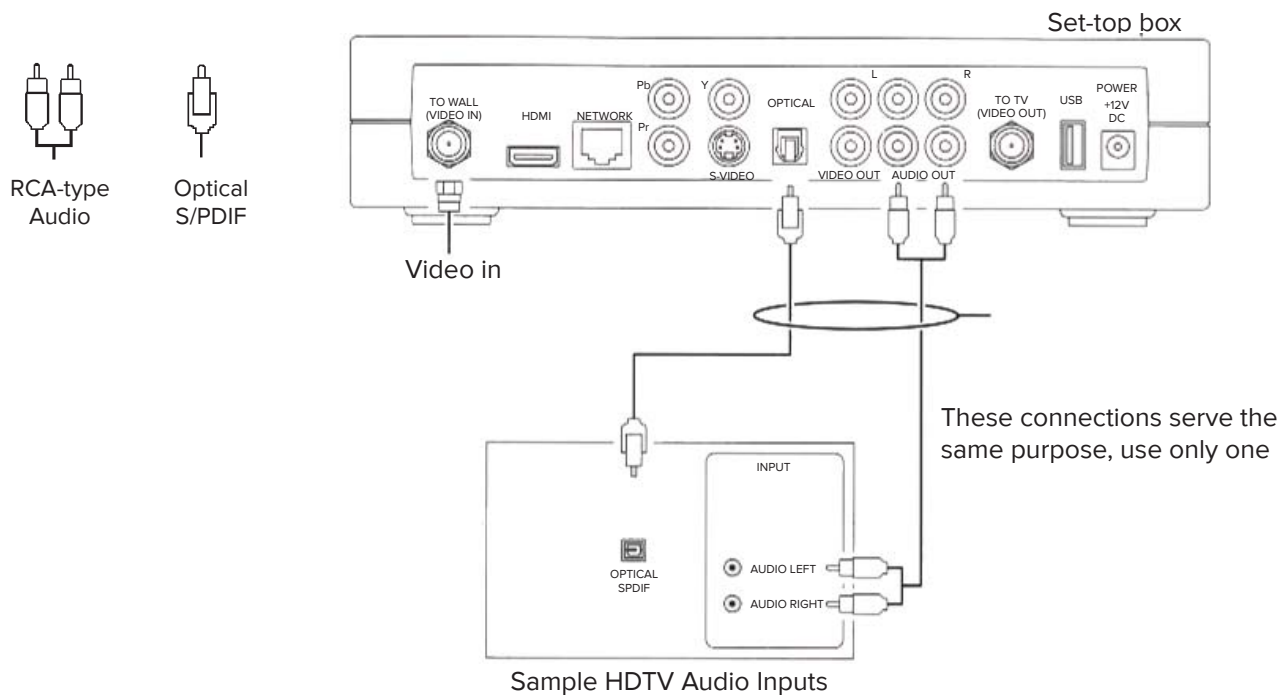

VIP 2262 – Option 1

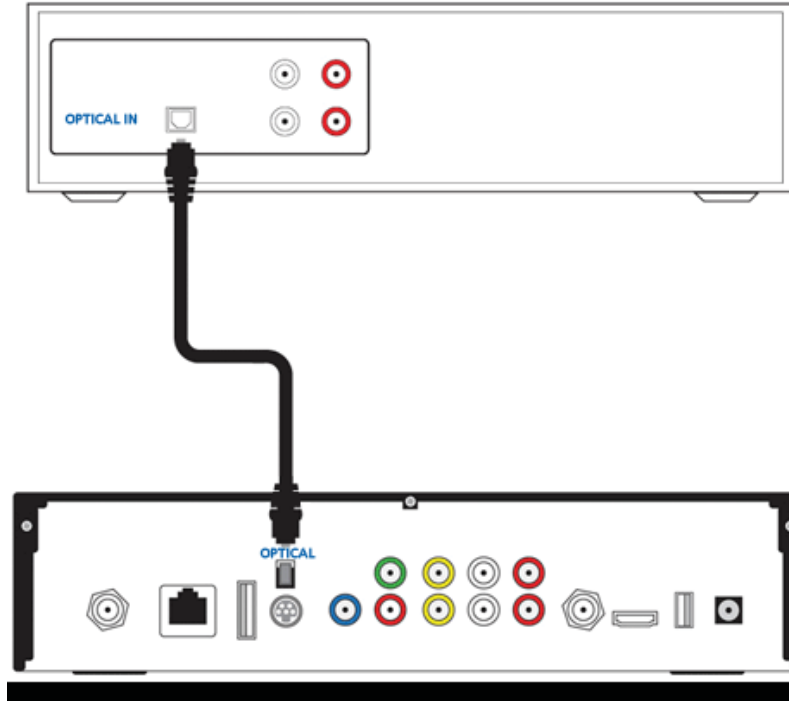

VIP 2262 – Option 2

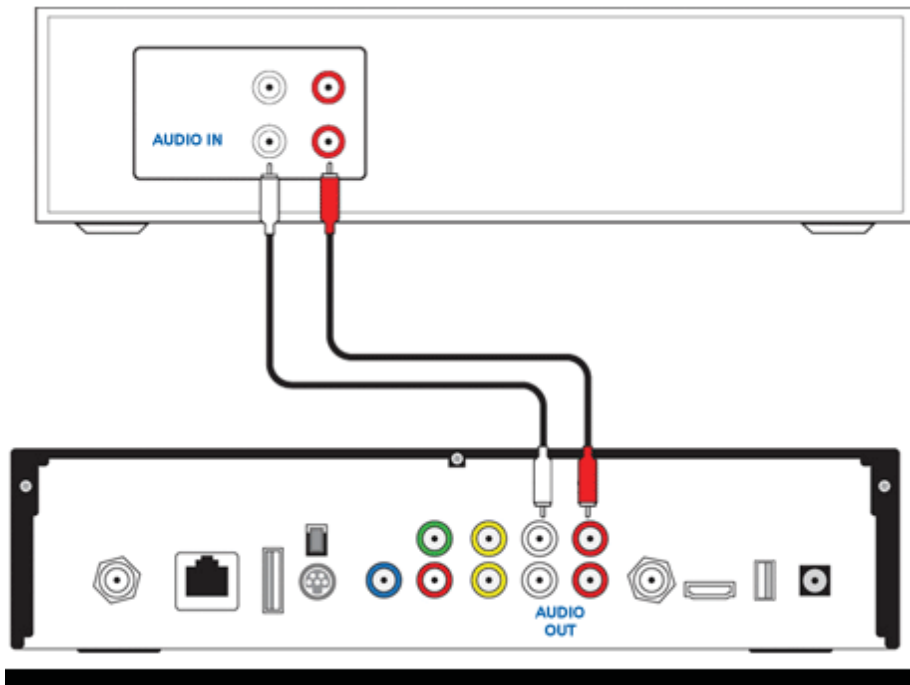

Connect to a stereo TV

- To determine your best connection, refer to Video Connection Options

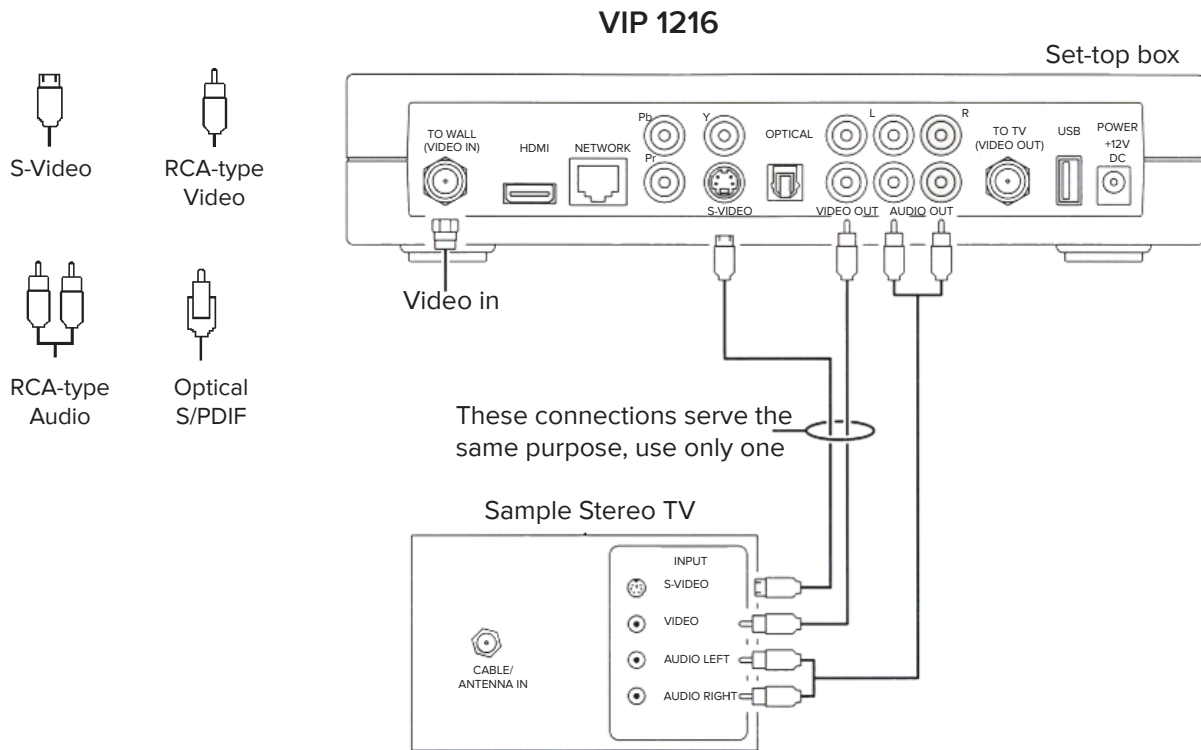

VIP 2262

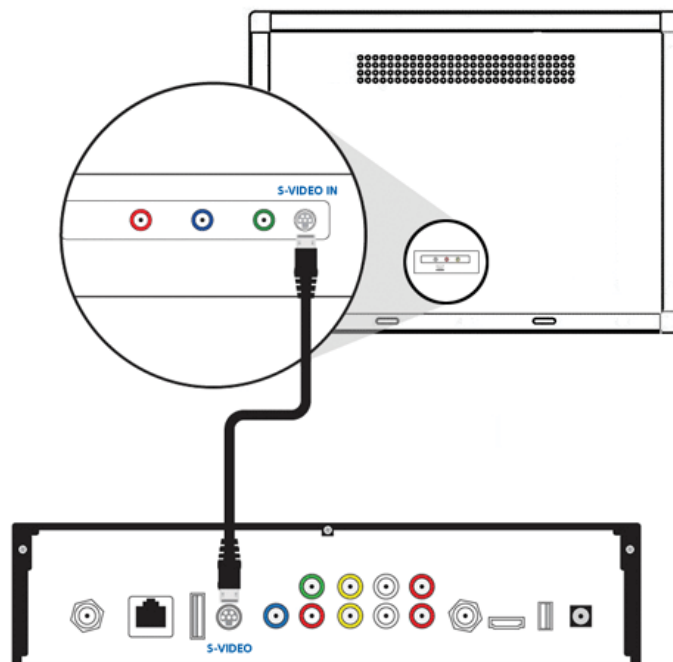

Connect to a stereo TV and stereo VCR

- To determine your best connection, refer to Video Connection Options
- This video connection method does not support HD video. For more information, see Connect an HDTV – Video Only

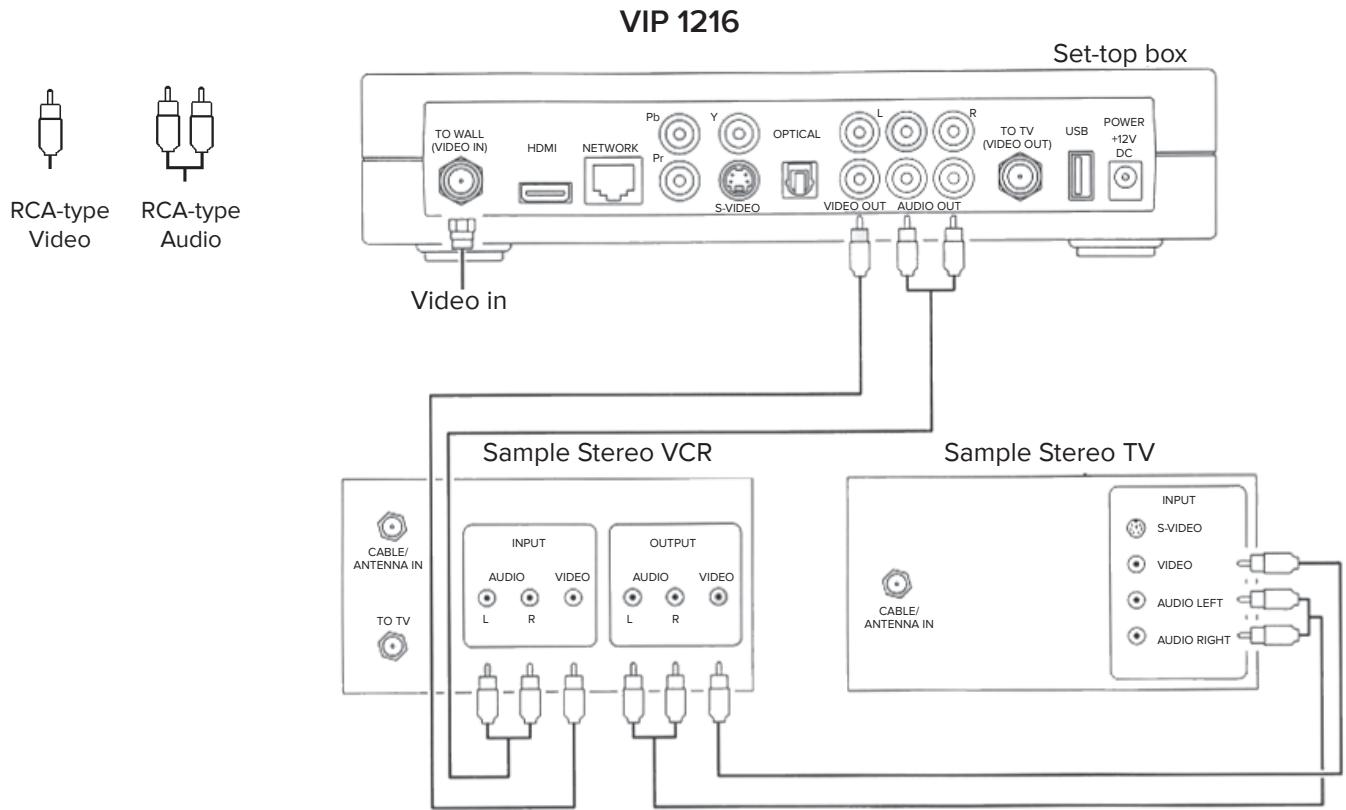

VIP 2262 – Option 1

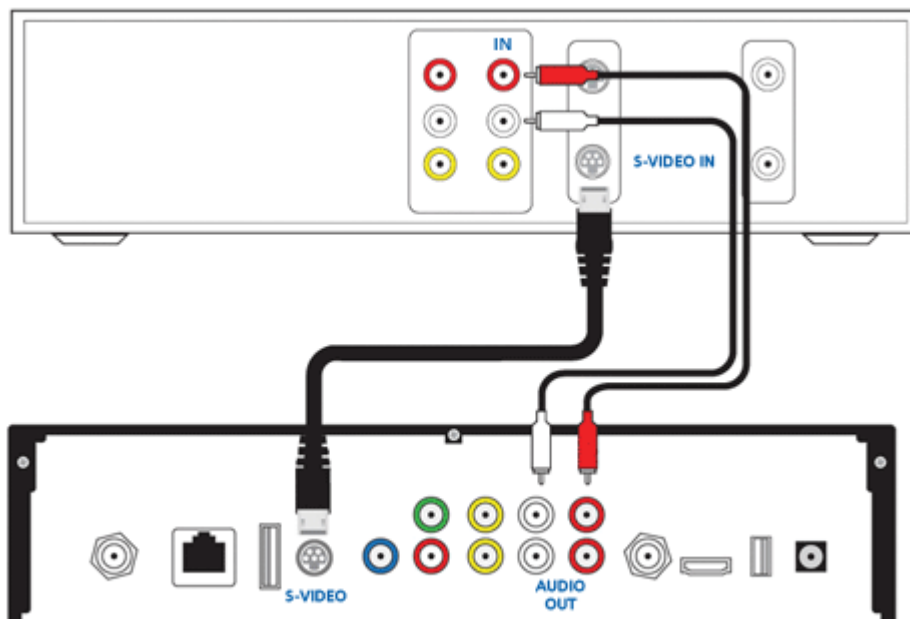

VIP 2262 – Option 2

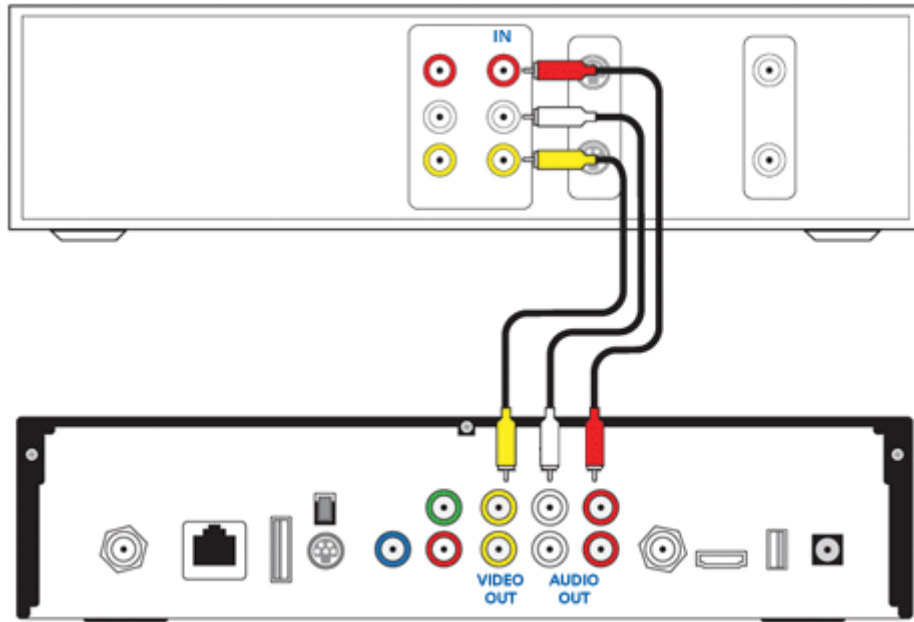

Connect to a home theatre receiver, TV, and VCR

- To determine your best connection, refer to Video Connection Options
- This video connection method does not support HD video. For more information, see Connect an HDTV – Video Only

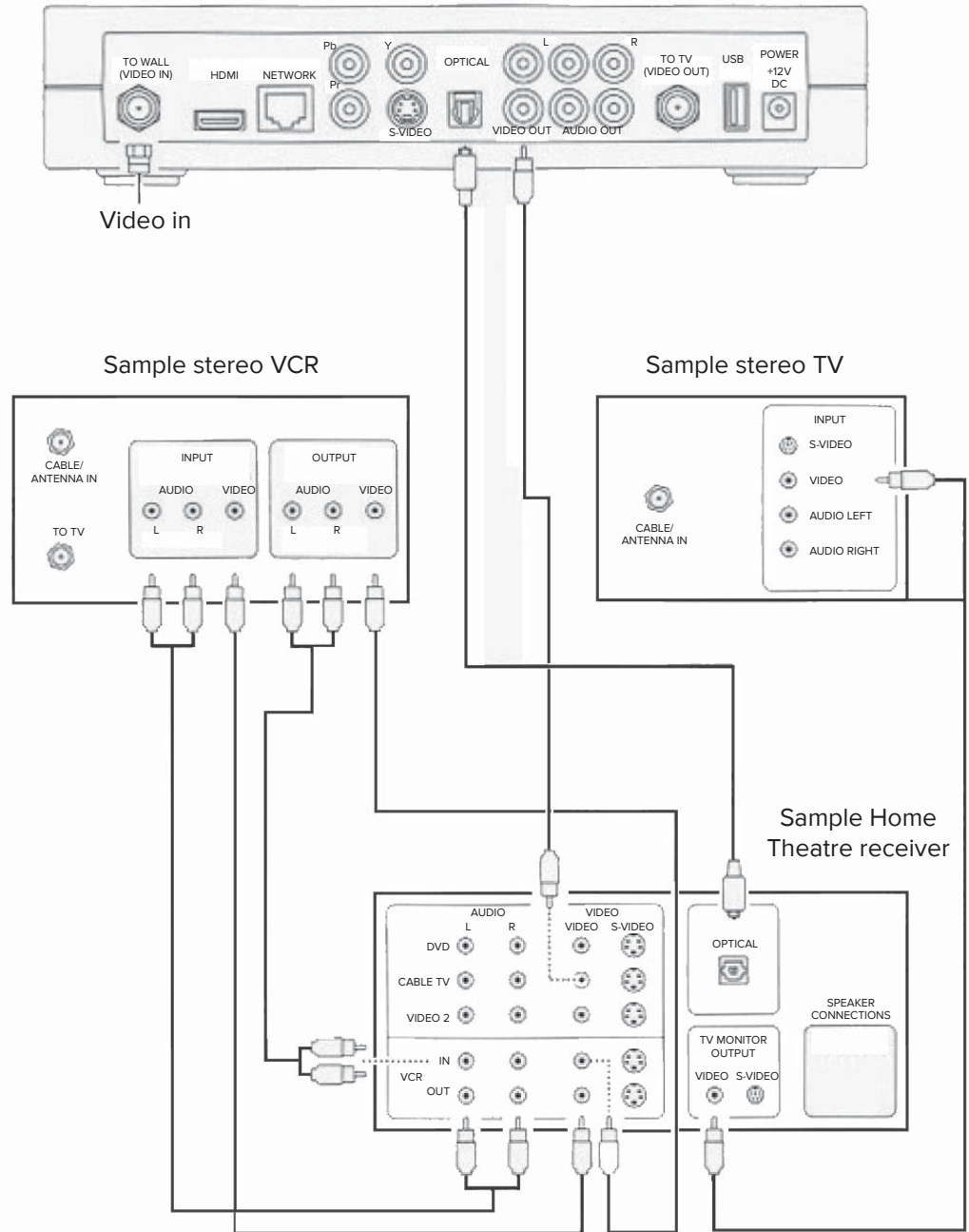
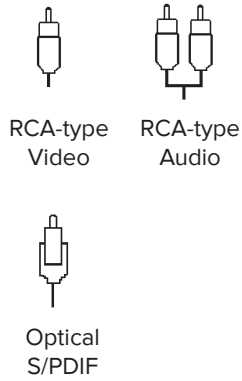

Troubleshooting

The below information should help you with troubleshooting issues with your MTS *Ultimate TV* service. If your problem is not resolved by this troubleshooting information, please call us, anytime, at 204-225-5687.

General Troubleshooting

Resetting the MTS *Ultimate TV* set-top box

- Press **MENU** on the remote control
- Use the **DOWN ARROW** to move to **SETTINGS** and press **OK**
- Use the **DOWN ARROW** to highlight **RESTART SYSTEM** and press **OK**
- Select **RESTART SYSTEM** and press **OK**
- The screen goes blank, the message “No video signal” displays for a few moments
- The MTS logo appears with the message “Please wait while system loads...”
- When the system completes the restart cycle live TV resumes playing

The MTS *Ultimate TV* set-top box will not power on

- Verify the power cord is securely connected to the set-top box and outlet. Unplug the set-top box from the outlet, plug it back in, and press the **POWER** button
- If the set-top box is connected to a switched outlet on another device, such as a VCR or home theatre receiver, verify the unit is powered on. Unplug the set-top box from the outlet, plug it back in, and press **POWER** button
- Press the **POWER** button on the set-top box front panel instead of the remote control because the batteries in the remote control may need to be changed

The MTS *Ultimate TV* set-top box is making a humming noise

The set-top box includes an integrated hard drive and a fan for cooling. During normal operation, it makes a quiet humming noise, similar to a personal computer. The noise varies in volume occasionally when the speed of the internal fan adjusts to changes in the temperature around the set-top box. The hard drive stays on even when the set-top box is turned off.

MTS *Ultimate TV* set-top box is warm to the touch

If the MTS *Ultimate TV* set-top box is warm, check the following:

- Ensure the vents on the set-top box are not blocked
- Do not place the set-top box on a rug or bed – this could cause overheating
- Do not stack equipment on the set-top box
- Maintain at least two inches of free space above the appliance
- Never place the set-top box near or on a heat source like a heating vent or radiator
- Ensure adequate ventilation around the set-top box

MTS *Ultimate TV* service is not available

The TV displays no signal, and the following message appears “Television is not currently available. Choose Restart to try connecting again. If this problem continues, contact MTS customer service. Error#259”

- Record the error code that appears in the message
- Select **RESTART** and press **OK**
- If service is not restored, contact MTS at 204-225-5687

Program Guide has no channel or program information

Occasionally, a delay occurs in the delivery of program Guide information.

- If the delay is more than a few minutes, press the **GUIDE** button to display the program guide, and then wait at least two minutes before taking further action

If cells in the program guide are labelled “No Information,” there may be a short delay in providing the program guide listings information. Or, you may have scrolled past the days for which the program guide has information, or there is no program guide information for those services.

- Press **EXIT TO TV** or **MENU** to leave the program guide
- Press **GUIDE** to return to the program guide and wait for at least two minutes

Audio and picture troubleshooting

There is no audio when viewing TV channels

Adjust set-top box audio level

- Press the **MENU**
- Use the **DOWN ARROW** to move to **SETTINGS**, press **OK**
- Use the **DOWN ARROW** to highlight **AUDIO**, press **OK**
- USE THE **RIGHT ARROW** to highlight **SET-TOP BOX AUDIO LEVEL**, press **OK**
- Highlight **MAX LEVEL**, press **OK**. Current set-top box audio level with display: **25**
- Highlight **MUTE OFF**, press **OK**. Current set-top box mute status will display: **unmuted**
- Highlight **DONE**, press **OK**



Mute and connection

- Check that the **MUTE** button on the remote control has not been pressed. Press **MUTE** on the remote control to restore sound
- Verify the set-top box audio output is connected to the TV or home theatre receiver
- If the set-top box audio output is connected to the TV, verify the **MUTE** button on the TV has not been pressed
- If the set-top box audio output is connected to a home theatre receiver, verify the home theatre receiver is set to the appropriate input source and its **MUTE** button has not been pressed

Volume

- Ensure the volume on the TV is turned up
- Control the volume by using the **VOLUME** button on the set-top box remote control, not the volume control on the TV remote control or on the TV set
- On some TV sets, you may need to use the TV controls to set the volume to full or slightly less than full before using the set-top box remote control to control the volume. In this case, use the TV controls to turn the volume all the way up, and then use the **VOLUME** button on the set-top box remote control

There is no audio from the centre and/or surrounding speakers of a home theatre receiver connected to the MTS *Ultimate TV* set-top box

- Not all Dolby Digital programs feature full 5.1 surround sound. In some cases the programs may only contain left and right stereo audio.
- Verify the S/PDIF cable is firmly connected to the set-top box and the home theatre receiver.
- Verify the home theatre receiver is set to a surround sound audio mode (Dolby Digital, Dolby Pro Logic® II, Dolby Pro Logic).
- Verify the home theatre receiver is properly configured to work with all connected speakers.

Video or audio is choppy, jerky, or of poor quality

The video or audio can be affected when the network is slow.

- Check to see if something else is running on the same Internet connection (like a graphics-intensive online video game). If there is something else running, end it and see if the quality of video and audio improves
- Restart the set-top box by unplugging it and plugging it back in. Pull the plug from the wall, not from the back of the set-top box

Audio and video are out of sync: Audio lags video or video lags audio

Sometimes the audio and video feeds can get out of sync. Ordinarily this problem can be resolved by backing up the video and watching it again, or by refreshing the video.

- Point the remote control at the set-top box and press the **REPLAY** button on the set-top box remote control. Try this several times
- Tune away from the current channel, and then tune back to it

Set-top box audio level

This allows you full control of adjusting the audio levels of the set-top box (This does not control the volume of your TV).

- Press **MENU**
- Use the **DOWN ARROW** to move to **SETTINGS**, press **OK**
- Use the **DOWN ARROW** to highlight **AUDIO**, press **OK**
- Highlight **SET-TOP BOX AUDIO LEVEL**, press **OK**
- Audio Level Settings Screen will be displayed

The following actions are available:

- **DONE** – Saves all current settings and exits to LiveTV
- **MAX LEVEL** – Sets the Set-top Box Audio level to maximum 25
- **INCREASE LEVEL +** – Increases the Audio Level by 1 to a maximum setting of 25
- **REDUCE LEVEL -** – Decreases the Audio Level by 1 to a minimum setting of 0
- **MUTE ON** – Sets the audio to mute
- **MUTE OFF** – Disables the mute setting



Increase/decrease set-top box volume



Mute/unmute set-top box volume



Setup Last button

The **LAST** button can either show you a list of the last 5 channels you have watched (called the Recent Panel), or tune you immediately to the last channel you were watching.

The **LAST** button is defaulted to show you the Recent Panel. The Recent Panel displays a list of the last 5 channels you have watched, and allows you to tune into any one of them.

If you prefer that the **LAST** button tune you immediately to the previous channel you have viewed, then you can choose to turn the Recent Panel feature off.

- Press **MENU**
- Use the **DOWN ARROW** to move to **SETTINGS**, press **OK**
- Highlight **TELEVISION**, press **OK**
- Highlight **SETUP LAST BUTTON**, press **OK**
 - Select **TURN THE RECENT PANEL FEATURE ON**, to turn on the Recent Panel
 - Select **TURN THE RECENT PANEL FEATURE OFF**, to turn off the Recent Panel
- Highlight **SAVE**, press **OK**



Program Guide and Menus are available but no video

- Ensure the TV, the set-top box, and all other relevant pieces of equipment are plugged in, turned on, and properly connected
 - Ensure the set-top box power switch is turned on
 - Ensure that electric sockets are live. Test by plugging in a lamp or some other device known to work
- Ensure that the Internet network connection is operational. Restart the set-top box by unplugging it and plugging it back in. Pull the plug from the wall, not from the back of the set-top box

PIPs are not displayed in any screen or menu

Picture-In-Pictures (PIPs) appear only for live TV programs and videos. PIPs do not appear for future programs or recorded programs.

- For future programs, the PIP space shows how many minutes until the program starts
- For recorded programs, the PIP space shows a graphic symbol

Snowy picture

- Check that all cables are connected and are tight to the TV, VCR (if applicable), and set-top box
- Ensure there is power to the set-top box. There should be a green light ring around the **POWER** button
- Ensure the set-top box is tightly plugged in at the back of the box and the plug is in a live electrical outlet
- Check that the VCR or DVD Player is powered off
- Check the TV physical connections. If the set-top box and TV are connected with a coax cable ensure that the RF output on the set-top box is going to the same channel your TV is set to
 - Press **MENU**
 - **DOWN ARROW** to **SETTINGS**
 - With **GENERAL** already highlighted press **OK**
 - **RIGHT ARROW** to **RF OUTPUT CHANNEL** and press **OK**
 - Ensure the number (3 or 4) is the same as the channel to which the TV is tuned

Changing TV screen aspect ratio

Changing the screen aspect ratio changes the screen dimensions for the video image and for the TV screens.

- Press **MENU**
- Press the **DOWN ARROW** button to highlight **SETTINGS**
- Highlight **TELEVISION**, and press **OK** Highlight **SCREEN ASPECT RATIO AND HIGH-DEFINITION**, and press **OK**
- Highlight the desired aspect ratio and resolution and press **OK** to activate
 - 4:3 STANDARD-DEFINITION – Used for ordinary televisions
 - WIDESCREEN STANDARD-DEFINITION – Used for wide-screen TVs (16:9 aspect ratio) that does not display in high-definition
 - 720P ON HIGH-DEFINITION SCREENS – Used for wide-screen TVs that display images 720 pixels wide (this is sometimes called “enhanced definition”)
 - 1080I ON HIGH-DEFINITION SCREENS – Used for wide-screen TVs that displays high-definition images (1080 pixels wide)
 - 1080p High Definition – Used if you have a widescreen TV that Displays high-definition 1080p images.
- Highlight **CONTINUE**, and press **OK**
- Select **CANCEL CHANGES** and press **OK** to exit from this screen without changing the aspect ratio

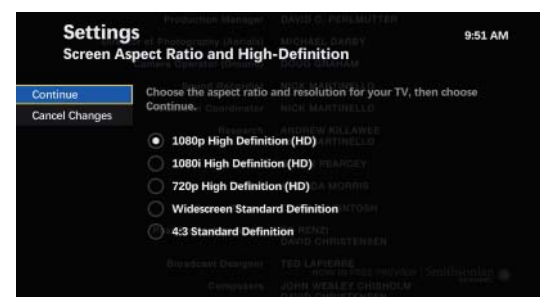
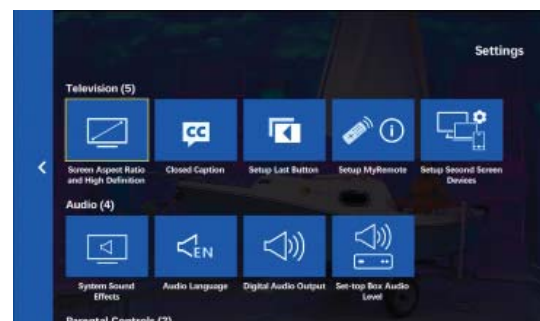

User Tip: To change aspect ratio of SD programming on an HDTV, press the aspect/enter button while watching a television program and a sub menu will appear, letting you select different aspect ratios including normal, stretch, and zoom. This aspect ratio will remain for all SD channels until it is changed again.

Turning system sound effects on and off

As you press buttons on your remote control, sound effects, such as beeps and clicks, are heard. You can turn these sound effects on and off as you choose.

- Press **MENU** on the remote control.
- Press the **DOWN ARROW** to highlight Settings on the vertical menu bar
- Press the **DOWN ARROW** to highlight Audio on the vertical menu bar
- Highlight **SYSTEM SOUND EFFECTS**, and press **OK**
- Highlight **PLAY SOUND EFFECTS** or **MUTE SOUND EFFECTS**, and press **OK**
- Highlight **SAVE**, and press **OK**.
- You can also select **DON'T SAVE** and press **OK** to exit from this screen without changing the sound effects setting.

To activate Digital Audio (Dolby 5.1 or AC3)

- Press **MENU**.
- Highlight **SETTINGS**
- Highlight **AUDIO**
- Highlight **DIGITAL AUDIO OUTPUT** and press **OK**
- Highlight **SURROUND SOUND** and press **OK**
- Highlight **SAVE** and press **OK**

I forgot my Home Networking password

Your Home Networking (home Wi-Fi) password is located on the back of your Residential Gateway.

Guide Troubleshooting

Channels are missing in the Program Guide

The program guide appears on-screen correctly, but some channels in the program guide are not showing. Check the Customize Channels Settings screen to determine if channels have been selected to not show in the guide.

This feature affects only the TV on which it was setup.

- Press **MENU**
- Press the **DOWN ARROW** button to highlight **SETTINGS**
- Highlight **GUIDE**, and press **OK**
- Highlight **CUSTOMIZE CHANNEL GUIDE**, and press **OK**
- Channels currently displayed in the guide have a check mark in front of them. Channels that are not currently displayed in guide do not have a check mark in front of them
- Use the **UP/DOWN ARROW** button or **CHIPG** to go through the list of channels. The following options are available:
 - **To hide a channel from the guide**
Highlight the channel, and press **OK**, the check mark disappears from the check box
 - **To make a hidden channel show in the guide**
Highlight the channel, and press **OK**, a check mark appears in front of the channel
 - **To see all channels in the guide**
Highlight **CHECK ALL** and press **OK**, check marks appear in all the check boxes
 - **To display only the unchecked boxes** (hidden channels)
Highlight **VIEW UNCHECKED**, and press **OK**, the **SHOW UNCHECKED** option becomes **SHOW ALL**
 - **To restore the entire list**
Highlight **SHOW ALL** and press **OK**
- To save the settings, highlight **SAVE** and press **OK**. Select **DON'T SAVE** to exit from the screen without saving the settings

Reset channels to original settings

- Press **MENU**
- Press the **DOWN ARROW** to highlight **SETTINGS**
- Highlight **GUIDE**, and press **OK**
- Highlight **CUSTOMIZE CHANNEL GUIDE**, and press **OK**
- Highlight **CHECK ALL** and press **OK**. Check marks appear in all the check boxes
- Highlight **SAVE** and press **OK**
- Press **EXIT** to return to live TV

View all channels

This will exit out of the current Favourites List

- Press **MENU**
- Under **LIVE TV**, highlight **FAVOURITES**, press **OK**
- To exit your Favourites list, select **VIEW ALL CHANNELS**, press **OK**

Disable Subscribed Channel filter

- Press **MENU**
- Press the **DOWN ARROW** button to highlight **SETTINGS**
- Highlight **GUIDE**, press **OK**
- Highlight **SUBSCRIBED CHANNELS SETTINGS**, press **OK**
- Select **VIEW ALL**, press **OK**
- Highlight **SAVE** and press **OK**

PVR Troubleshooting

Cannot record a program

- Ensure the set-top box has PVR functionality and that you are subscribed to the MTS PVR service
- Movies and programs within the Video on Demand service are copy-written material and cannot be recorded
- Individually scheduled recordings are marked by a red dot and series recordings are marked by three overlapping dots
- Some channels do not permit recording. If you try to record them you get an error message. This is normal and expected as there is no way to record those channels
- If you are trying to record too many programs at once, some of them won't record. They will appear in your guide with a red circle and an X next to the program name. To resolve conflicts, see the "Conflicts" section of this guide

Recording to an external device like a VCR or DVD recorder

Verify the device is plugged in, turned on, and properly connected. Consult the documentation for the external device for information about proper connection of the external hard disk drive.

Only the tuned channel will record using a VCR or DVD recorder.

All actions using the remote control will record, including changing volume. (Anything on your screen will be recorded.)

Program scheduled to record does not record

- Press **RECORDED TV**. If the program recorded, this screen lists the program. Do one of the following:
 - If the Recorded TV screen lists the program, select the program in the list and play it
 - With the program highlighted press **OK**
 - Highlight **PLAY** and press **OK**

If there is no indication the program recorded, continue with the following:

A different program recorded

- Press **RECORDED TV**. Does the Recorded TV screen list a program that was recorded on the same day and at the same time as the program that you wanted to record? If so, another program was scheduled to record in that time slot and the resulting conflict was resolved in favour of the other program

Record based on time slot (not program name)

Series recording is based on the time slot and not on the name of the series. If a series is scheduled to record for 11:00 AM every day, it records whatever is on that channel at 11:00 AM every day.

Remote Troubleshooting

The remote control is working intermittently or does not work

- Verify the TV is on
- Check the batteries in the remote control and install new batteries if needed
- Ensure there are no obstructions between the remote control and the set-top box. Point the remote control directly at the set-top box front panel, not at the TV or VCR
- Make sure the **STB/MTS** button is pressed to make sure your remote is in the right mode
- The angle between the remote control and the set-top box may be too large. Stand in front of the set-top box and not too far to either side
- Press and release operation keys one at a time, firmly and deliberately
- Try changing the channels using the **UP** and **DOWN ARROW** keys on the set-top box front panel. The light on the remote control should flash on while you change the channel

TV quick fixes

- Press **STB/MTS**, located at the top left-hand side of your remote, to ensure that the operating mode is set to MTS Ultimate TV service (On some remotes, this button is labelled “MTS”)
- Make sure you are within 20 feet of your set-top box and have a clear line of sight with no obstructions (including glass doors)
- Check the batteries in the remote control and replace them if needed
- On some TVs, the brightness settings can interfere with the signal from your remote to your set-top box. Try adjusting the brightness on your TV set
- Check that there is power to your set-top box. You will see a green light around the power button on the front panel
- Check that your TV's Input/Source is set to the type of cable that is connecting the MTS Ultimate TV set-top box to your TV set (i.e., Component or HDMI)
- Check that your cables are firmly attached to the TV and set-top box
- Remove any items that may have been placed on any MTS Ultimate TV equipment. All equipment needs at least two inches of free space for proper ventilation. Do not place any MTS equipment on a rug or bed as it may overheat
- Turn your set-top box off and on by pressing the **POWER** button on your set-top box to reset the system

Remember

- To instantly change your channel groups online, visit mts.ca/myaccount
- You must have an HD TV set to view HD-quality TV signals